



Visual Tagging Solutions

Safety. Maintenance. Identification.

Visual Tagging Solutions

TABLE OF CONTENTS

Plant, Vehicles, Machinery & Tools

Forkliftag® Daily Inspection Booklet and Forkliftag® 6
 Nanotag™, Unitag® and Microtag® for Lifting Equipment..... 7 - 9
 MEWP Tag and Multitag® 10
 Unitag®, Nanotag™ and Microtag® for Machinery 11 - 13
 Microtag®, Nanotag™ and Unitag® for Electrical Equipment 14 - 16
 Microtag® for HAVs - Vibration/Noise and Vibration/Points System... 17 - 18
 Nanotag™ for Fire and Emergency Equipment..... 19

Working at Height

Scaffitag® MK1 and Scaffitag® MK2 20
 Scaffolding Special Status Inserts, Scaffolding Prohibition Inserts and Structural Tie Tags 21
 Scaffold Quarantine Tag and Towertag® 22
 Laddertag® 23
 Microtag® and Nanotag™ for Steps & Stools 24 - 25
 Nanotag™ for Harness 26

Workspace Control

Entrytag® 27
 Man In Confined Space Tag and Man In Tank Tag..... 27
 Permit Wallets, Pen Clip Holder and Chemtag® 28

Process & Pipelines

Flange Tag and Isolation Tag 29

Accessories

Adhesive Strips, Black Cable Ties, Split Ring Attachment for Nanotag, Stainless Steel Cable Ties, Metal Fixing Ring for Man in Tank Insert, Wire Strops, Reusable Cable Ties, Pen Clip Holder, Worker ID Tag, Permit Wallets, Permanent Marking Pens, Clear Cover Inserts and Blank Inserts..... 30 - 33

How to Use Guide

Forkliftag®, Nanotag™, Unitag®, Microtag®, MEWP Tag, Multitag®, Scaffitag®, Laddertag®, Towertag®, Entrytag®, Chemtag® and Isolation Tag..... 34 - 39

Index

Product Index 40 - 45

Think about any item of equipment on your site:

- How do you know it is fit for use?
- When was it last inspected?
- How do you identify it among the hundreds of similar items on site?

Without the latest information, people are prone to make assumptions. And assumptions can lead to potentially damaging decisions for both them and your business. The identity, maintenance and inspection status of equipment is therefore critical.



Did You Know?

All the **Brady Visual Tagging Solutions** illustrated in this catalogue are available in a variety of languages.

For the article number corresponding to the relevant languages, please turn to the **Product Index** on **pages 40 to 45**.



English



German



French



Dutch



Norwegian



Finnish



Swedish



Turkish



Russian



Danish

What are visual tags?

Visual tags help:

- Communicate the latest equipment inspection and test status clearly at the point of use
- Record an audit trail of recent equipment maintenance, tests and inspections
- Uniquely identify equipment
- Comply with Health and Safety legislation
- Reduce accidents in the work place

We can help you with Visual Tagging for Work at Height, Plant, Vehicles, Machinery & Tools, Workspace Control and Process & Pipelines.

In fact, whatever your equipment – we can tag it

HOLDER AND INSERT SYSTEM

Our visual tags typically comprise of two components:



Holder

Attaches to the equipment being tagged.



Insert

Placed in the holder and used to record and display the latest equipment status.

Holder and Insert Work Together in a Looped Process



1

Attach

The empty holder displays 'DO NOT USE...' symbol and is attached to equipment.

2

Inspect

Equipment is inspected periodically, as deemed appropriate by risk assessment, and the results recorded on the insert.

3

Insert

If the equipment passes inspection then the insert is placed in the holder, displaying the latest equipment information to any users.

If equipment fails inspection at any point, then simply remove the insert from the holder to display the 'DO NOT USE...' sign.

Attachment Methods



Magnetic Strip



Adhesive Strip



Split Ring



Hang Loop



Cable Ties



Strop

CUSTOMISE YOUR VISUAL TAGGING

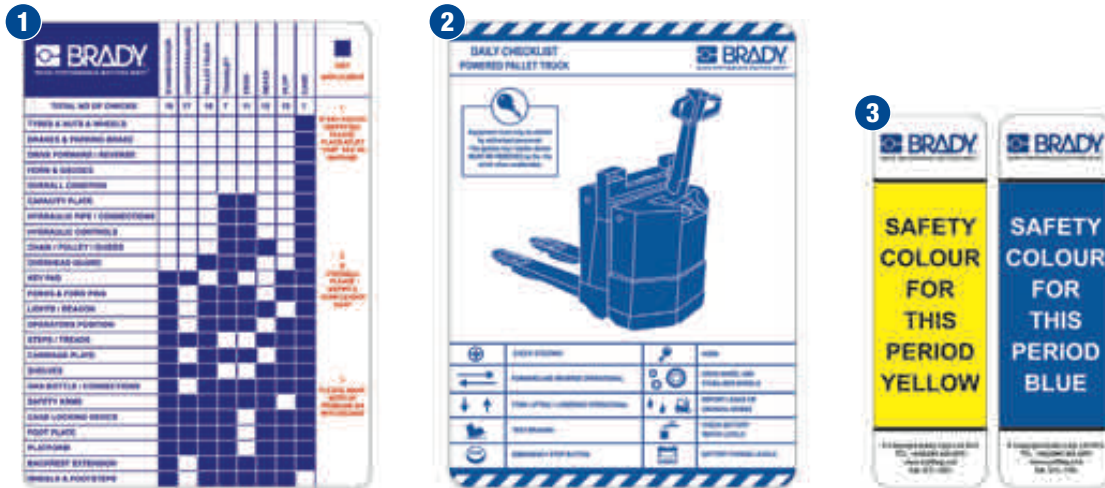

We can custom design Visual Tagging Solutions to help you manage virtually any issue and fit seamlessly with your business and systems. A wide range of customisation options are available including:

- Tag size and shape
- Data to be displayed/recorded
- Visual design including logo, colours and fonts to reflect corporate branding
- Adapt to site requirements e.g. Metal strips for magnetic detection in food plants
- Attachment methods e.g. cable tie, split ring, magnetic, adhesive

A Library of Ideas

We have literally thousands of designs developed for other clients offering unique solutions which may be of interest to your business.

We do not charge any consultancy fees for working with you to develop your customised design. All you pay is a one off artwork set up charge with your first order. You can then reorder paying the price of the standard insert and holders used for your solution.

So whatever your issue, contact us for a no-obligation solution.

1 Plant Machinery Inspection Checklist

An inspection checklist for a wide variety of plant machinery, from stand stackers to pallet trucks, consolidating in one custom designed and branded tag.

2 Pallet Truck Inspection Checklist

Company colour scheme and branding applied to a custom inspection checklist for a fleet of powered pallet trucks ensuring consistency of branding.

3 Colour Coded Safety System

A custom designed colour coded system indicating a safe working period on site. Prominent use of your logo enforces the concept that the safe working policy originates with the company itself and not a third party.

PERSONALISE YOUR VISUAL TAGGING SOLUTION

Brady's personalisation service allows you to add your company logo to our range of standard visual tags, while the design of the tagging system remains unchanged.



Logo printed on holder hang loop

Logo printed at the top of holder body

Logo printed on white strip at head of insert

Add your logo to:

- Our standard inserts - most of our inserts are designed with a white band ready to accommodate your branding
- To the holder - Typically printed at the top of the holders main body
- The upper curve of the holders hang loop (not available on Laddertag®, Nanotag™, Multitag®, Microtag®, Unitag®)



How Do you Get your Artwork Personalised?

A logo needs to be supplied in the correct file format and suitable quality for artwork personalisation. Ideally all logos will be supplied in vector format, and any colours e.g. Pantone references, need to be specified.

Colour Information

When sending your artwork files you will also need to supply the correct colour information for your product. Please indicate the PMS (Pantone Matching System) colour required, but if in doubt this can be discussed with our artwork department beforehand.

Image Resolution

We require high quality black and white line artwork, printed at a minimum of 300 dpi, must be 100% of the actual imprint size. Artwork must have crisp, sharp edges and needs no further touch up. Some thin lines, small copy and reverses may not reproduce as submitted and may need to be altered to print clearly.

PLEASE DO NOT SUPPLY EITHER SCANNED OR IMAGES WHICH HAVE BEEN PLACED IN OTHER DOCUMENTS SUCH AS WORD, POWERPOINT ETC.

General Information

Reduce the file size if possible, particularly if you plan to send the artwork by e-mail. Use one of the following programs to compress your file: WinZip, 7-Zip. Using compression software is essential when e-mailing vector graphics (AI, EPS, CDR).

WE REQUIRE ALL VECTOR GRAPHICS/PHOTOSHOP DOCUMENTS TO BE SAVED IN ADOBE CREATIVE SUITE VERSION 3 (CS3) FORMAT. ALL CORELDRAW DOCUMENTS NEED TO BE SAVED AS SINGLE PAGES. ALL EPS FILES NEED TO BE SAVED IN AN EDITABLE FORMAT.



FORKLIFTAG® DAILY INSPECTION BOOKLET

The Forkliftag® Daily Inspection Booklet can record up to 252 daily inspections.

- Fits in our Forkliftag holder
- Contains an easy-to-follow pre-use operator guide
- Contains Machine Defect Report
- Sign and date your inspection checks with any type of pen

Insert

Material: Polypropylene

Temperature Range: -10 °C to +90 °C



Article No.	Order Reference	Description	Height (mm)	Width (mm)	Packaging
833758	FLT-DCB	Forkliftag Booklet	193.00	144.00	Booklet with 6 pages of daily inspection boxes. Fits in the Forkliftag Holder.



FORKLIFTAG®

Forklift inspection system to help control pre-shift inspections, maintenance and identification of forklift trucks.

- Easy-to-follow pre-use operator checklist
- Record up to 42 daily inspections
- Attach to forklift by cable tie or adhesive

Holder

- Material: ABS (Acrylonitrile Butadiene Styrene) thermoplastic
- Temperature Range: -5 °C to +65 °C
- Attachment Method: Cable Tie, Adhesive Strip

Insert

- Material: Polypropylene
- Temperature Range: -10 °C to +90 °C



Please turn to **page 34** for a Forkliftag how to use guide.

Article No.	Order Reference	Description	Height (mm)	Width (mm)	Packaging
Holders Only					
136594	FLT-GB-ETSH-V2-A	Forkliftag Holder	260.00	153.00	10 Forkliftag Holders
Inserts Only					
806699	FLT-GB-ETSI-51-10	Forkliftag Insert	193.00	144.00	10 Forkliftag Inserts
806695	FLT-GB-ETSI-51-50	Forkliftag Insert	193.00	144.00	50 Forkliftag Inserts
Kits - Holders & Inserts					
136116	FLT-GB-ETI-51-V2-1-A	Forkliftag Kit	-	-	1 Forkliftag Holder, 5 Forkliftag Inserts, 1 Pen
136160	FLT-GB-ETI-51-V2-2-A	Forkliftag Kit	-	-	2 Forkliftag Holders, 10 Forkliftag Inserts, 1 Pen
136202	FLT-GB-ETI-51-V2-3-A	Forkliftag Kit	-	-	3 Forkliftag Holders, 15 Forkliftag Inserts, 1 Pen
136247	FLT-GB-ETI-51-V2-4-A	Forkliftag Kit	-	-	4 Forkliftag Holder, 20 Forkliftag Inserts, 1 Pen
136291	FLT-GB-ETI-51-V2-5-A	Forkliftag Kit	-	-	5 Forkliftag Holder, 25 Forkliftag Inserts, 1 Pen
138385	FLT-GB-ETI-51-V2-A	Forkliftag Kit	-	-	10 Forkliftag Holders, 10 Forkliftag Inserts, 1 Pen

NANOTAG™ FOR LIFTING EQUIPMENT

Nanotag for lifting equipment is designed to clearly display the SWL (Safe Working Load) / Next Inspection Date Due at the point of use.

- A selection of coloured inserts are available providing the option of additional visual qualification
- NAN I insert can record the SWL (Safe Working Load) and Next Inspection Date Due

Holder

- **Material:** Nylon 6
- **Temperature Range:** -20 °C to +80 °C
- **Attachment Method:** Split Ring, Cable Tie
- **Extra Feature:** Embedded RFID chip as standard

Insert

- **Material:** Polypropylene
- **Temperature Range:** -10 °C to +90 °C
- **Design:** Identical both sides



Please turn to [page 34](#) for a Nanotag how to use guide.

Article No.	Order Reference	Description	Text/Legend	Colour	Height (mm)	Width (mm)	Packaging
Holders Only							
833302	NAN-NAN-A	Nanotag Holder		Red on White	54.00	26.00	20 Nanotag Holders, 40 Cable Ties (150mm), 1 Pen
Inserts Only							
833331	NAN-NAN-I-RD-20	Nanotag Insert	Safe Working Load, Next Inspection Date Due	White on Red	34.00	18.00	20 Nanotag Inserts
833332	NAN-NAN-I-BL-20	Nanotag Insert	Safe Working Load, Next Inspection Date Due	White on Blue	34.00	18.00	20 Nanotag Inserts
833333	NAN-NAN-I-YL-20	Nanotag Insert	Safe Working Load, Next Inspection Date Due	Black on Yellow	34.00	18.00	20 Nanotag Inserts
833334	NAN-NAN-I-GN-20	Nanotag Insert	Safe Working Load, Next Inspection Date Due	White on Green	34.00	18.00	20 Nanotag Inserts
833335	NAN-NAN-I-WH-20	Nanotag Insert	Safe Working Load, Next Inspection Date Due	Black on White	34.00	18.00	20 Nanotag Inserts
833336	NAN-NAN-I-PL-20	Nanotag Insert	Safe Working Load, Next Inspection Date Due	White on Purple	34.00	18.00	20 Nanotag Inserts
833337	NAN-NAN-I-OR-20	Nanotag Insert	Safe Working Load, Next Inspection Date Due	White on Orange	34.00	18.00	20 Nanotag Inserts
Kits - Holders & Inserts							
833338	NAN-PK-NAN-I-YL	Nanotag Kit	Safe Working Load, Next Inspection Date Due	Black on Yellow	-	-	20 Nanotag Holders, 20 Nanotag Inserts, 1 Pen
833339	NAN-PK-NAN-I-RD	Nanotag Kit	Safe Working Load, Next Inspection Date Due	White on Red	-	-	20 Nanotag Holders, 20 Nanotag Inserts, 1 Pen
833340	NAN-PK-NAN-I-GN	Nanotag Kit	Safe Working Load, Next Inspection Date Due	White on Green	-	-	20 Nanotag Holders, 20 Nanotag Inserts, 1 Pen
833341	NAN-PK-NAN-I-BL	Nanotag Kit	Safe Working Load, Next Inspection Date Due	White on Blue	-	-	20 Nanotag Holders, 20 Nanotag Inserts, 1 Pen
833342	NAN-PK-NAN-I-PL	Nanotag Kit	Safe Working Load, Next Inspection Date Due	White on Purple	-	-	20 Nanotag Holders, 20 Nanotag Inserts, 1 Pen
833343	NAN-PK-NAN-I-OR	Nanotag Kit	Safe Working Load, Next Inspection Date Due	White on Orange	-	-	20 Nanotag Holders, 20 Nanotag Inserts, 1 Pen
833344	NAN-PK-NAN-I-WH	Nanotag Kit	Safe Working Load, Next Inspection Date Due	Black on White	-	-	20 Nanotag Holders, 20 Nanotag Inserts, 1 Pen

The **Brady Visual Tagging Solutions** illustrated in this catalogue are available in a variety of languages. For the product order codes corresponding to the relevant languages, please turn to [pages 40 to 45](#).



English



German



French



Dutch



Norwegian



Finnish



Swedish



Turkish



Russian



Danish

UNITAG® FOR LIFTING EQUIPMENT

Unitag for lifting equipment is designed to clearly display the SWL / Next Inspection Date Due at the point of use.

- A selection of coloured inserts are available providing the option of additional visual qualification
- UNI I insert can record the SWL (Safe Working Load) and Next Inspection Date Due
- Unitag holders can be supplied with Nylon, Stainless Steel or Plastic Wire Coated Strop attachments

Holder

- **Material:** Nylon 6
- **Temperature Range:** -20 °C to +80 °C
- **Attachment Method:** Strop

Insert

Material: Polypropylene
Temperature Range: -10 °C to +90 °C
Design: Identical both sides



Please turn to **page 35** for a Unitag how to use guide.



Article No.	Order Reference	Description	Text/Legend	Colour	Diameter (mm)	Packaging
Holders Only						
806787	UNI-UNH-6-SS-A	Unitag Holder	Do Not Use	Red on White	50.00	20 Unitag Holders, 20 Stainless Steel Stropps (150mm), 1 Pen
832718	UNI-UNH-6-A	Unitag Holder	Do Not Use	Red on White	50.00	20 Unitag Holders, 20 Nylon Stropps (150mm), 1 Pen
832720	UNI-UNH-6-PC-A	Unitag Holder	Do Not Use	Red on White	50.00	20 Unitag Holders, 20 Plastic Coated Wire Stropps (150mm), 1 Pen
832721	UNI-UNH-9-A	Unitag Holder	Do Not Use	Red on White	50.00	20 Unitag Holders, 20 Nylon Stropps (225mm), 1 Pen
832722	UNI-UNH-9-SS-A	Unitag Holder	Do Not Use	Red on White	50.00	20 Unitag Holders, 20 Stainless Steel Stropps (225mm), 1 Pen
832723	UNI-UNH-9-PC-A	Unitag Holder	Do Not Use	Red on White	50.00	20 Unitag Holders, 20 Plastic Coated Wire Stropps (225mm), 1 Pen
832724	UNI-UNH-12-A	Unitag Holder	Do Not Use	Red on White	50.00	20 Unitag Holders, 20 Nylon Stropps (300mm), 1 Pen
Inserts Only						
832733	UNI-UNI-I-WH-20	Unitag Insert	Safe Working Load, Next Inspection Date Due	Black on White	41.00	20 Unitag Inserts
832734	UNI-UNI-I-PL-20	Unitag Insert	Safe Working Load, Next Inspection Date Due	White on Purple	41.00	20 Unitag Inserts
832735	UNI-UNI-I-OR-20	Unitag Insert	Safe Working Load, Next Inspection Date Due	White on Orange	41.00	20 Unitag Inserts
832736	UNI-UNI-I-GN-20	Unitag Insert	Safe Working Load, Next Inspection Date Due	White on Green	41.00	20 Unitag Inserts
832737	UNI-UNI-I-BL-20	Unitag Insert	Safe Working Load, Next Inspection Date Due	White on Blue	41.00	20 Unitag Inserts
832738	UNI-UNI-I-RD-20	Unitag Insert	Safe Working Load, Next Inspection Date Due	White on Red	41.00	20 Unitag Inserts
832739	UNI-UNI-I-YL-20	Unitag Insert	Safe Working Load, Next Inspection Date Due	Black on Yellow	41.00	20 Unitag Inserts
Kits - Holders & Inserts						
832740	UNI-PK-UNI-I-RD	Unitag Kit	Safe Working Load, Next Inspection Date Due	White on Red	-	20 Unitag Holders, 20 Unitag Inserts, 20 Nylon Stropps (225mm), 1 Pen
832741	UNI-PK-UNI-I-YL	Unitag Kit	Safe Working Load, Next Inspection Date Due	Black on Yellow	-	20 Unitag Holders, 20 Unitag Inserts, 20 Nylon Stropps (225mm), 1 Pen
832742	UNI-PK-UNI-I-BL	Unitag Kit	Safe Working Load, Next Inspection Date Due	White on Blue	-	20 Unitag Holders, 20 Unitag Inserts, 20 Nylon Stropps (225mm), 1 Pen
832743	UNI-PK-UNI-I-WH	Unitag Kit	Safe Working Load, Next Inspection Date Due	Black on White	-	20 Unitag Holders, 20 Unitag Inserts, 20 Nylon Stropps (225mm), 1 Pen
832744	UNI-PK-UNI-I-PL	Unitag Kit	Safe Working Load, Next Inspection Date Due	White on Purple	-	20 Unitag Holders, 20 Unitag Inserts, 20 Nylon Stropps (225mm), 1 Pen
832745	UNI-PK-UNI-I-OR	Unitag Kit	Safe Working Load, Next Inspection Date Due	White on Orange	-	20 Unitag Holders, 20 Unitag Inserts, 20 Nylon Stropps (225mm), 1 Pen
832746	UNI-PK-UNI-I-GN	Unitag Kit	Safe Working Load, Next Inspection Date Due	White on Green	-	20 Unitag Holders, 20 Unitag Inserts, 20 Nylon Stropps (225mm), 1 Pen

MICROTAG® FOR LIFTING EQUIPMENT

Microtag for lifting equipment is designed to clearly display the SWL (Safe Working Load) / Next Inspection Date Due at the point of use.

- A selection of coloured inserts are available providing the option of additional visual qualification
- MTI I insert can record the SWL (Safe Working Load) and Next Inspection Date Due

Holder

- **Material:** Nylon 6
- **Temperature Range:** -20 °C to +80 °C
- **Attachment Method:** Cable Tie, Adhesive Strip

Insert

- **Material:** Polypropylene
- **Temperature Range:** -10 °C to +90 °C
- **Design:** Identical both sides



Please turn to [page 35](#) for a Microtag how to use guide.



Article No.	Order Reference	Description	Text/Legend	Colour	Height (mm)	Width (mm)	Packaging
Holders Only							
806723	MIC-MTH-A	Microtag Holder	Do Not Use Equipment	Red on White	81.00	38.00	20 Microtag Holders, 40 Cable Ties (150mm), 1 Pen
Inserts Only							
831994	MIC-MTI-I-BL-20	Microtag Insert	Safe Working Load, Next Inspection Date Due	White on Blue	47.00	30.00	20 Microtag Inserts
831995	MIC-MTI-I-GN-20	Microtag Insert	Safe Working Load, Next Inspection Date Due	White on Green	47.00	30.00	20 Microtag Inserts
831996	MIC-MTI-I-OR-20	Microtag Insert	Safe Working Load, Next Inspection Date Due	White on Orange	47.00	30.00	20 Microtag Inserts
831997	MIC-MTI-I-PL-20	Microtag Insert	Safe Working Load, Next Inspection Date Due	White on Purple	47.00	30.00	20 Microtag Inserts
831998	MIC-MTI-I-RD-20	Microtag Insert	Safe Working Load, Next Inspection Date Due	White on Red	47.00	30.00	20 Microtag Inserts
831999	MIC-MTI-I-YL-20	Microtag Insert	Safe Working Load, Next Inspection Date Due	Black on Yellow	47.00	30.00	20 Microtag Inserts
832000	MIC-MTI-I-WH-20	Microtag Insert	Safe Working Load, Next Inspection Date Due	Black on White	47.00	30.00	20 Microtag Inserts
Kits - Holders & Inserts							
832001	MIC-PK-MTI-I-BL	Microtag Kit	Safe Working Load, Next Inspection Date Due	White on Blue	-	-	20 Microtag Holders, 20 Microtag Inserts, 1 Pen
832002	MIC-PK-MTI-I-YL	Microtag Kit	Safe Working Load, Next Inspection Date Due	Black on Yellow	-	-	20 Microtag Holders, 20 Microtag Inserts, 1 Pen
832003	MIC-PK-MTI-I-RD	Microtag Kit	Safe Working Load, Next Inspection Date Due	White on Red	-	-	20 Microtag Holders, 20 Microtag Inserts, 1 Pen
832004	MIC-PK-MTI-I-GN	Microtag Kit	Safe Working Load, Next Inspection Date Due	White on Green	-	-	20 Microtag Holders, 20 Microtag Inserts, 1 Pen
832005	MIC-PK-MTI-I-WH	Microtag Kit	Safe Working Load, Next Inspection Date Due	Black on White	-	-	20 Microtag Holders, 20 Microtag Inserts, 1 Pen
832006	MIC-PK-MTI-I-OR	Microtag Kit	Safe Working Load, Next Inspection Date Due	White on Orange	-	-	20 Microtag Holders, 20 Microtag Inserts, 1 Pen
832007	MIC-PK-MTI-I-PL	Microtag Kit	Safe Working Load, Next Inspection Date Due	White on Purple	-	-	20 Microtag Holders, 20 Microtag Inserts, 1 Pen

The **Brady Visual Tagging Solutions** illustrated in this catalogue are available in a variety of languages. For the product order codes corresponding to the relevant languages, please turn to [pages 40 to 45](#).





MEWP TAG

MEWP Tag is designed to help control frequent inspections, maintenance and identification of MEWPs (Mobile Elevating Work Platforms).

- The MEWP Tag Insert contains an easy-to-follow pre-use operator checklist and space to record up to 32 inspections
- The holder provides multiple attachment options such as cable tie or adhesive.
- Ensures MEWP operators are informed of latest equipment status clearly at the point of use

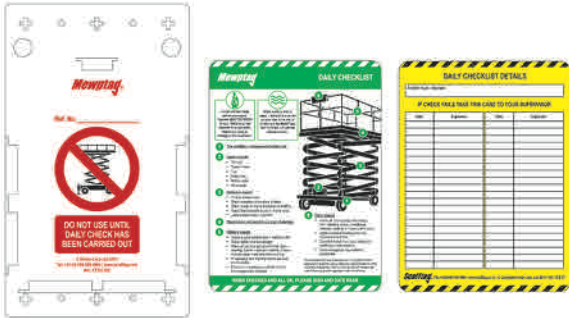

Holder

- **Material:** ABS (Acrylonitrile Butadiene Styrene) thermoplastic
- **Temperature Range:** -5 °C to +65 °C
- **Attachment Method:** Cable Tie, Adhesive Strip

Insert

- **Material:** Polypropylene
- **Temperature Range:** -10 °C to +90 °C



Please turn to **page 36** for a MEWP tag how to use guide.

Article No.	Order Reference	Description	Height (mm)	Width (mm)	Packaging
Holders Only					
137800	MEWP-GB-ETSH-500-V2-A	Mobile Elevating Work Platforms Holder	260.00	153.00	10 MEWP Tag Holders
Inserts Only					
831778	MEWP-GB-ETSI-550-10	Mobile Elevating Work Platforms Insert	193.00	144.00	10 MEWP Tag Inserts
831779	MEWP-GB-ETSI-550-50	Mobile Elevating Work Platforms Insert	193.00	144.00	50 MEWP Tag Inserts
Kits - Holders & Inserts					
136136	MEWP-GB-ETI-550-V2-1-A	Mobile Elevating Work Platforms Kit	-	-	1 MEWP Tag Holders, 5 MEWP Tag Inserts, 1 Pen
136182	MEWP-GB-ETI-550-V2-2-A	Mobile Elevating Work Platforms Kit	-	-	2 MEWP Tag Holders, 10 MEWP Tag Inserts, 1 Pen
136224	MEWP-GB-ETI-550-V2-3-A	Mobile Elevating Work Platforms Kit	-	-	3 MEWP Tag Holders, 15 MEWP Tag Inserts, 1 Pen
136269	MEWP-GB-ETI-550-V2-4-A	Mobile Elevating Work Platforms Kit	-	-	4 MEWP Tag Holders, 20 MEWP Tag Inserts, 1 Pen
136313	MEWP-GB-ETI-550-V2-5-A	Mobile Elevating Work Platforms Kit	-	-	5 MEWP Tag Holders, 25 MEWP Tag Inserts, 1 Pen
137778	MEWP-GB-ETI-550-V2-A	Mobile Elevating Work Platforms Kit	-	-	10 MEWP Tag Holders, 10 MEWP Tag Inserts, 1 Pen
Accessories					
833759	SUND-PENHOLDER	Pen Clip Holder	-	-	Pack of 10



MULTITAG®

Multitag is popular for managing production line machinery where control panels have restricted space for attachment of a tag.

- Ensures machinery operators are aware of equipment status, risks and warnings
- Records up to 12 records of Next Inspection Due Date

Holder

- **Material:** Polycarbonate
- **Temperature Range:** -20 °C to +130 °C
- **Attachment Method:** Cable Tie, Adhesive Strip

Insert

- **Material:** Polypropylene
- **Temperature Range:** -10 °C to +90 °C



Please turn to **page 36** for a Multitag how to use guide.

Article No.	Order Reference	Description	Height (mm)	Width (mm)	Packaging
Holders Only					
831904	MUL-GB-EITH-A	Multitag Holder	210.00	55.00	10 Multitag Holders
Inserts Only					
806743	MUL-GB-EITL-STD-50	Multitag Insert	164.00	50.00	50 Multitag Inserts
806747	MUL-GB-EITL-STD-10	Multitag Insert	164.00	50.00	10 Multitag Inserts
Kits - Holders & Inserts					
806739	MUL-GB-EITH-L-A	Multitag Kit	-	-	10 Multitag Holders, 10 Multitag Inserts, 1 Pen

UNITAG® FOR MACHINERY

Unitag for Machinery is designed to clearly display the Next Inspection Date Due / Next Test Date at the point of use.

- A selection of coloured inserts are available providing the option of additional visual qualification
- UNI GP insert records the Next Test Date
- UNI GPI insert records Next Inspection Date Due
- Unitag holders supplied with Nylon, Stainless Steel or Plastic Wire Coated Strop attachments

Holder

- Material: Nylon 6
- Temperature Range: -20 °C to +80 °C
- Attachment Method: Strop

Insert

- Material: Polypropylene
- Temperature Range: -10 °C to +90 °C
- Design: Identical both sides



Please turn to **page 35** for a Unitag how to use guide.



Legend:
Next Inspection Date Due



Legend:
Next Test Date

Article No.	Order Reference	Description	Text/Legend	Colour	Diameter (mm)	Packaging
Holders Only						
806787	UNI-UNH-6-SS-A	Unitag Holder	Do Not Use	Red on White	50.00	20 Unitag Holders, 20 Stainless Steel Stropps (150mm), 1 Pen
832718	UNI-UNH-6-A	Unitag Holder	Do Not Use	Red on White	50.00	20 Unitag Holders, 20 Nylon Stropps (150mm), 1 Pen
832720	UNI-UNH-6-PC-A	Unitag Holder	Do Not Use	Red on White	50.00	20 Unitag Holders, 20 Plastic Coated Wire Stropps (150mm), 1 Pen
832721	UNI-UNH-9-A	Unitag Holder	Do Not Use	Red on White	50.00	20 Unitag Holders, 20 Nylon Stropps (225mm), 1 Pen
832722	UNI-UNH-9-SS-A	Unitag Holder	Do Not Use	Red on White	50.00	20 Unitag Holders, 20 Stainless Steel Stropps (225mm), 1 Pen
832723	UNI-UNH-9-PC-A	Unitag Holder	Do Not Use	Red on White	50.00	20 Unitag Holders, 20 Plastic Coated Wire Stropps (225mm), 1 Pen
832724	UNI-UNH-12-A	Unitag Holder	Do Not Use	Red on White	50.00	20 Unitag Holders, 20 Nylon Stropps (300mm), 1 Pen
Inserts Only						
806791	UNI-UNI-GPI-GN-20	Unitag Insert	Next Inspection Date Due	White on Green	41.00	20 Unitag Inserts
806795	UNI-UNI-GPI-RD-20	Unitag Insert	Next Inspection Date Due	White on Red	41.00	20 Unitag Inserts
806799	UNI-UNI-GPI-YL-20	Unitag Insert	Next Inspection Date Due	Black on Yellow	41.00	20 Unitag Inserts
832763	UNI-UNI-GPI-BL-20	Unitag Insert	Next Inspection Date Due	White on Blue	41.00	20 Unitag Inserts
832765	UNI-UNI-GPI-OR-20	Unitag Insert	Next Inspection Date Due	White on Orange	41.00	20 Unitag Inserts
832766	UNI-UNI-GPI-PL-20	Unitag Insert	Next Inspection Date Due	White on Purple	41.00	20 Unitag Inserts
832767	UNI-UNI-GPI-WH-20	Unitag Insert	Next Inspection Date Due	Black on White	41.00	20 Unitag Inserts
832747	UNI-UNI-GP-RD-20	Unitag Insert	Next Test Date	White on Red	41.00	20 Unitag Inserts
832748	UNI-UNI-GP-BL-20	Unitag Insert	Next Test Date	White on Blue	41.00	20 Unitag Inserts
832749	UNI-UNI-GP-GN-20	Unitag Insert	Next Test Date	White on Green	41.00	20 Unitag Inserts
832750	UNI-UNI-GP-OR-20	Unitag Insert	Next Test Date	White on Orange	41.00	20 Unitag Inserts
832751	UNI-UNI-GP-PL-20	Unitag Insert	Next Test Date	White on Purple	41.00	20 Unitag Inserts
832752	UNI-UNI-GP-WH-20	Unitag Insert	Next Test Date	Black on White	41.00	20 Unitag Inserts
832753	UNI-UNI-GP-YL-20	Unitag Insert	Next Test Date	Black on Yellow	41.00	20 Unitag Inserts
Kits - Holders & Inserts						
832768	UNI-PK-GPI-BL	Unitag Kit	Next Inspection Date Due	White on Blue	-	20 Unitag Holders, 20 Nylon Stropps (225mm), 20 Unitag Inserts
832769	UNI-PK-GPI-RD	Unitag Kit	Next Inspection Date Due	White on Red	-	20 Unitag Holders, 20 Nylon Stropps (225mm), 20 Unitag Inserts
832770	UNI-PK-GPI-GN	Unitag Kit	Next Inspection Date Due	White on Green	-	20 Unitag Holders, 20 Nylon Stropps (225mm), 20 Unitag Inserts
832771	UNI-PK-GPI-YL	Unitag Kit	Next Inspection Date Due	Black on Yellow	-	20 Unitag Holders, 20 Nylon Stropps (225mm), 20 Unitag Inserts
832772	UNI-PK-GPI-OR	Unitag Kit	Next Inspection Date Due	White on Orange	-	20 Unitag Holders, 20 Nylon Stropps (225mm), 20 Unitag Inserts
832773	UNI-PK-GPI-PL	Unitag Kit	Next Inspection Date Due	White on Purple	-	20 Unitag Holders, 20 Nylon Stropps (225mm), 20 Unitag Inserts
832774	UNI-PK-GPI-WH	Unitag Kit	Next Inspection Date Due	Black on White	-	20 Unitag Holders, 20 Nylon Stropps (225mm), 20 Unitag Inserts
832754	UNI-PK-GP-YL	Unitag Kit	Next Test Date	Black on Yellow	-	20 Unitag Holders, 20 Nylon Stropps (225mm), 20 Unitag Inserts
832755	UNI-PK-GP-GN	Unitag Kit	Next Test Date	White on Green	-	20 Unitag Holders, 20 Nylon Stropps (225mm), 20 Unitag Inserts
832756	UNI-PK-GP-RD	Unitag Kit	Next Test Date	White on Red	-	20 Unitag Holders, 20 Nylon Stropps (225mm), 20 Unitag Inserts
832758	UNI-PK-GP-BL	Unitag Kit	Next Test Date	White on Blue	-	20 Unitag Holders, 20 Nylon Stropps (225mm), 20 Unitag Inserts
832759	UNI-PK-GP-PL	Unitag Kit	Next Test Date	White on Purple	-	20 Unitag Holders, 20 Nylon Stropps (225mm), 20 Unitag Inserts
832760	UNI-PK-GP-OR	Unitag Kit	Next Test Date	White on Orange	-	20 Unitag Holders, 20 Nylon Stropps (225mm), 20 Unitag Inserts

The **Brady Visual Tagging Solutions** illustrated in this catalogue are available in a variety of languages.

For the product order codes corresponding to the relevant languages, please turn to **pages 40 to 45**.



English



German



French



Dutch



Norwegian



Finnish



Swedish



Turkish



Russian



Danish

NANOTAG™ FOR MACHINERY

Nanotag for Machinery is designed to clearly display the Next Inspection Date Due / Next Test Date at the point of use.

- A selection of coloured inserts are available providing the option of additional visual qualification
- NAN GP insert records the Next Test Date
- NAN GPI insert records Next Inspection Date Due

Holder

- **Material:** Nylon 6
- **Temperature Range:** -20 °C to +80 °C
- **Attachment Method:** Split Ring, Cable Tie
- **Extra Feature:** Embedded RFID chip as standard

Insert

- **Material:** Polypropylene
- **Temperature Range:** -10 °C to +90 °C
- **Design:** Identical both sides



Please turn to [page 34](#) for a Nanotag how to use guide.



Legend:
Next Inspection
Date Due

Legend:
Next Test
Date

Article No.	Order Reference	Description	Text/Legend	Colour	Height (mm)	Width (mm)	Packaging
Holders Only							
833302	NAN-NAN-A	Nanotag Holder		Red on White	54.00	26.00	20 Nanotag Holders, 40 Cable Ties (150mm), 1 Pen
Inserts Only							
833303	NAN-NAN-GP-OR-20	Nanotag Insert	Next Test Date	White on Orange	34.00	18.00	20 Nanotag Inserts
833304	NAN-NAN-GP-YL-20	Nanotag Insert	Next Test Date	Black on Yellow	34.00	18.00	20 Nanotag Inserts
833305	NAN-NAN-GP-BL-20	Nanotag Insert	Next Test Date	White on Blue	34.00	18.00	20 Nanotag Inserts
833306	NAN-NAN-GP-GN-20	Nanotag Insert	Next Test Date	White on Green	34.00	18.00	20 Nanotag Inserts
833307	NAN-NAN-GP-RD-20	Nanotag Insert	Next Test Date	White on Red	34.00	18.00	20 Nanotag Inserts
833308	NAN-NAN-GP-WH-20	Nanotag Insert	Next Test Date	Black on White	34.00	18.00	20 Nanotag Inserts
833309	NAN-NAN-GP-PL-20	Nanotag Insert	Next Test Date	White on Purple	34.00	18.00	20 Nanotag Inserts
833317	NAN-NAN-GPI-YL-20	Nanotag Insert	Next Inspection Date Due	Black on Yellow	34.00	18.00	20 Nanotag Inserts
833318	NAN-NAN-GPI-OR-20	Nanotag Insert	Next Inspection Date Due	White on Orange	34.00	18.00	20 Nanotag Inserts
833319	NAN-NAN-GPI-RD-20	Nanotag Insert	Next Inspection Date Due	White on Red	34.00	18.00	20 Nanotag Inserts
833320	NAN-NAN-GPI-BL-20	Nanotag Insert	Next Inspection Date Due	White on Blue	34.00	18.00	20 Nanotag Inserts
833321	NAN-NAN-GPI-GN-20	Nanotag Insert	Next Inspection Date Due	White on Green	34.00	18.00	20 Nanotag Inserts
833322	NAN-NAN-GPI-PL-20	Nanotag Insert	Next Inspection Date Due	White on Purple	34.00	18.00	20 Nanotag Inserts
833323	NAN-NAN-GPI-WH-20	Nanotag Insert	Next Inspection Date Due	Black on White	34.00	18.00	20 Nanotag Inserts
Kits - Holders & Inserts							
833310	NAN-PK-GP-BL	Nanotag Kit	Next Test Date	White on Blue	-	-	20 Nanotag Holders, 20 Nanotag Inserts, 1 Pen
833311	NAN-PK-GP-PL	Nanotag Kit	Next Test Date	White on Purple	-	-	20 Nanotag Holders, 20 Nanotag Inserts, 1 Pen
833312	NAN-PK-GP-YL	Nanotag Kit	Next Test Date	Black on Yellow	-	-	20 Nanotag Holders, 20 Nanotag Inserts, 1 Pen
833313	NAN-PK-GP-GN	Nanotag Kit	Next Test Date	White on Green	-	-	20 Nanotag Holders, 20 Nanotag Inserts, 1 Pen
833314	NAN-PK-GP-OR	Nanotag Kit	Next Test Date	White on Orange	-	-	20 Nanotag Holders, 20 Nanotag Inserts, 1 Pen
833315	NAN-PK-GP-RD	Nanotag Kit	Next Test Date	White on Red	-	-	20 Nanotag Holders, 20 Nanotag Inserts, 1 Pen
833316	NAN-PK-GP-WH	Nanotag Kit	Next Test Date	Black on White	-	-	20 Nanotag Holders, 20 Nanotag Inserts, 1 Pen
833324	NAN-PK-GPI-PL	Nanotag Kit	Next Inspection Date Due	White on Purple	-	-	20 Nanotag Holders, 20 Nanotag Inserts, 1 Pen
833325	NAN-PK-GPI-BL	Nanotag Kit	Next Inspection Date Due	White on Blue	-	-	20 Nanotag Holders, 20 Nanotag Inserts, 1 Pen
833326	NAN-PK-GPI-GN	Nanotag Kit	Next Inspection Date Due	White on Green	-	-	20 Nanotag Holders, 20 Nanotag Inserts, 1 Pen
833327	NAN-PK-GPI-RD	Nanotag Kit	Next Inspection Date Due	White on Red	-	-	20 Nanotag Holders, 20 Nanotag Inserts, 1 Pen
833328	NAN-PK-GPI-OR	Nanotag Kit	Next Inspection Date Due	White on Orange	-	-	20 Nanotag Holders, 20 Nanotag Inserts, 1 Pen
833329	NAN-PK-GPI-WH	Nanotag Kit	Next Inspection Date Due	Black on White	-	-	20 Nanotag Holders, 20 Nanotag Inserts, 1 Pen
833330	NAN-PK-GPI-YL	Nanotag Kit	Next Inspection Date Due	Black on Yellow	-	-	20 Nanotag Holders, 20 Nanotag Inserts, 1 Pen



NANOTAG™ HOLDER STEEL CABLE TIE ATTACHMENT METHOD

The attachment slots running through the middle of the holders are large enough to accommodate stainless steel cable ties. [See page 30 for more details.](#)

MICROTAG® FOR MACHINERY

Microtag for Machinery is designed to clearly display the Next Inspection Date Due / Next Test Date at the point of use.

- A selection of coloured inserts are available providing the option of additional visual qualification
- MTI GP insert records the Next Test Date
- MTI GPI insert records Next Inspection Date Due
- A barcoded Microtag holder is also available

Holder

- **Material:** Nylon 6
- **Temperature Range:** -20 °C to +80 °C
- **Attachment Method:** Cable Tie, Adhesive Strip

Insert

- **Material:** Polypropylene
- **Temperature Range:** -10 °C to +90 °C
- **Design:** Identical both sides

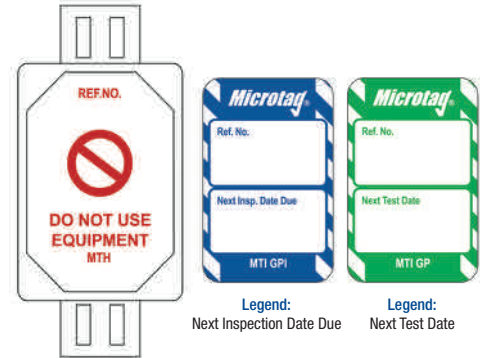
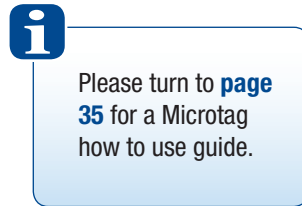

Article No.	Order Reference	Description	Text/Legend	Colour	Height (mm)	Width (mm)	Packaging
Holders Only							
831979	MIC-MTH-BARCODE-A	Microtag Barcode Holder	Do Not Use Equipment	Red on White	81.00	38.00	20 Microtag Bar-Code Holders, 40 Cable Ties (150mm), 1 Pen
806723	MIC-MTH-A	Microtag Holder	Do Not Use Equipment	Red on White	81.00	38.00	20 Microtag Holders, 40 Cable Ties (150mm), 1 Pen
Inserts Only							
806731	MIC-MTI-GPI-RD-20	Microtag Insert	Next Inspection Date Due	White on Red	47.00	30.00	20 Microtag Inserts
806735	MIC-MTI-GPI-YL-20	Microtag Insert	Next Inspection Date Due	Black on Yellow	47.00	30.00	20 Microtag Inserts
832008	MIC-MTI-GPI-BL-20	Microtag Insert	Next Inspection Date Due	White on Blue	47.00	30.00	20 Microtag Inserts
832009	MIC-MTI-GPI-GN-20	Microtag Insert	Next Inspection Date Due	White on Green	47.00	30.00	20 Microtag Inserts
832010	MIC-MTI-GPI-OR-20	Microtag Insert	Next Inspection Date Due	White on Orange	47.00	30.00	20 Microtag Inserts
832011	MIC-MTI-GPI-PL-20	Microtag Insert	Next Inspection Date Due	White on Purple	47.00	30.00	20 Microtag Inserts
832012	MIC-MTI-GPI-WH-20	Microtag Insert	Next Inspection Date Due	Black on White	47.00	30.00	20 Microtag Inserts
831981	MIC-MTI-GP-BL-20	Microtag Insert	Next Test Date	White on Blue	47.00	30.00	20 Microtag Inserts
831982	MIC-MTI-GP-GN-20	Microtag Insert	Next Test Date	White on Green	47.00	30.00	20 Microtag Inserts
831983	MIC-MTI-GP-OR-20	Microtag Insert	Next Test Date	White on Orange	47.00	30.00	20 Microtag Inserts
831984	MIC-MTI-GP-PL-20	Microtag Insert	Next Test Date	White on Purple	47.00	30.00	20 Microtag Inserts
831985	MIC-MTI-GP-WH-20	Microtag Insert	Next Test Date	Black on White	47.00	30.00	20 Microtag Inserts
831986	MIC-MTI-GP-YL-20	Microtag Insert	Next Test Date	Black on Yellow	47.00	30.00	20 Microtag Inserts
Kits - Holders & Inserts							
832015	MIC-PK-GPI-YL	Microtag Kit	Next Inspection Date Due	Black on Yellow	-	-	20 Microtag Holders, 20 Microtag Inserts, 1 Pen
832016	MIC-PK-GPI-PL	Microtag Kit	Next Inspection Date Due	White on Purple	-	-	20 Microtag Holders, 20 Microtag Inserts, 1 Pen
832017	MIC-PK-GPI-WH	Microtag Kit	Next Inspection Date Due	Black on White	-	-	20 Microtag Holders, 20 Microtag Inserts, 1 Pen
832018	MIC-PK-GPI-RD	Microtag Kit	Next Inspection Date Due	White on Red	-	-	20 Microtag Holders, 20 Microtag Inserts, 1 Pen
832019	MIC-PK-GPI-OR	Microtag Kit	Next Inspection Date Due	White on Orange	-	-	20 Microtag Holders, 20 Microtag Inserts, 1 Pen
832020	MIC-PK-GPI-GN	Microtag Kit	Next Inspection Date Due	White on Green	-	-	20 Microtag Holders, 20 Microtag Inserts, 1 Pen
832021	MIC-PK-GPI-BL	Microtag Kit	Next Inspection Date Due	White on Blue	-	-	20 Microtag Holders, 20 Microtag Inserts, 1 Pen
831987	MIC-PK-GP-GN	Microtag Kit	Next Test Date	White on Green	-	-	20 Microtag Holders, 20 Microtag Inserts, 1 Pen
831988	MIC-PK-GP-BL	Microtag Kit	Next Test Date	White on Blue	-	-	20 Microtag Holders, 20 Microtag Inserts, 1 Pen
831989	MIC-PK-GP-RD	Microtag Kit	Next Test Date	White on Red	-	-	20 Microtag Holders, 20 Microtag Inserts, 1 Pen
831990	MIC-PK-GP-OR	Microtag Kit	Next Test Date	White on Orange	-	-	20 Microtag Holders, 20 Microtag Inserts, 1 Pen
831991	MIC-PK-GP-YL	Microtag Kit	Next Test Date	Black on Yellow	-	-	20 Microtag Holders, 20 Microtag Inserts, 1 Pen
831992	MIC-PK-GP-PL	Microtag Kit	Next Test Date	White on Purple	-	-	20 Microtag Holders, 20 Microtag Inserts, 1 Pen
831993	MIC-PK-GP-WH	Microtag Kit	Next Test Date	Black on White	-	-	20 Microtag Holders, 20 Microtag Inserts, 1 Pen

The **Brady Visual Tagging Solutions** illustrated in this catalogue are available in a variety of languages.

For the product order codes corresponding to the relevant languages, please turn to **pages 40 to 45**.





MICROTAG® FOR ELECTRICAL EQUIPMENT

Microtag for Electrical Equipment is designed to clearly display the Next Inspection Date Due / Next Test Date at the point of use.

- A selection of coloured inserts are available providing the option of additional visual qualification
- MTI GP insert records the Next Test Date
- A barcoded Microtag holder is also available

Holder

- **Material:** Nylon 6
- **Temperature Range:** -20 °C to +80 °C
- **Attachment Method:** Cable Tie, Adhesive Strip

Insert

- **Material:** Polypropylene
- **Temperature Range:** -10 °C to +90 °C
- **Design:** Identical both sides



Please turn to [page 35](#) for a Microtag how to use guide.

Article No.	Order Reference	Description	Text/Legend	Colour	Height (mm)	Width (mm)	Packaging
Holders Only							
831979	MIC-MTH-BARCODE-A	Microtag Barcode Holder	Do Not Use Equipment	Red on White	81.00	38.00	20 Microtag Bar-Code Holders, 40 Cable Ties (150mm), 1 Pen
806723	MIC-MTH-A	Microtag Holder	Do Not Use Equipment	Red on White	81.00	38.00	20 Microtag Holders, 40 Cable Ties (150mm), 1 Pen
Inserts Only							
831980	MIC-MTI-GP-RD-20	Microtag Insert	Next Test Date	White on Red	47.00	30.00	20 Microtag Inserts
831981	MIC-MTI-GP-BL-20	Microtag Insert	Next Test Date	White on Blue	47.00	30.00	20 Microtag Inserts
831982	MIC-MTI-GP-GN-20	Microtag Insert	Next Test Date	White on Green	47.00	30.00	20 Microtag Inserts
831983	MIC-MTI-GP-OR-20	Microtag Insert	Next Test Date	White on Orange	47.00	30.00	20 Microtag Inserts
831984	MIC-MTI-GP-PL-20	Microtag Insert	Next Test Date	White on Purple	47.00	30.00	20 Microtag Inserts
831985	MIC-MTI-GP-WH-20	Microtag Insert	Next Test Date	Black on White	47.00	30.00	20 Microtag Inserts
831986	MIC-MTI-GP-YL-20	Microtag Insert	Next Test Date	Black on Yellow	47.00	30.00	20 Microtag Inserts
Kits - Holders & Inserts							
831987	MIC-PK-GP-GN	Microtag Kit	Next Test Date	White on Green	-	-	20 Microtag Holders, 20 Microtag Inserts, 1 Pen
831988	MIC-PK-GP-BL	Microtag Kit	Next Test Date	White on Blue	-	-	20 Microtag Holders, 20 Microtag Inserts, 1 Pen
831989	MIC-PK-GP-RD	Microtag Kit	Next Test Date	White on Red	-	-	20 Microtag Holders, 20 Microtag Inserts, 1 Pen
831990	MIC-PK-GP-OR	Microtag Kit	Next Test Date	White on Orange	-	-	20 Microtag Holders, 20 Microtag Inserts, 1 Pen
831991	MIC-PK-GP-YL	Microtag Kit	Next Test Date	Black on Yellow	-	-	20 Microtag Holders, 20 Microtag Inserts, 1 Pen
831992	MIC-PK-GP-PL	Microtag Kit	Next Test Date	White on Purple	-	-	20 Microtag Holders, 20 Microtag Inserts, 1 Pen
831993	MIC-PK-GP-WH	Microtag Kit	Next Test Date	Black on White	-	-	20 Microtag Holders, 20 Microtag Inserts, 1 Pen



MICROTAG® NYLON CABLE TIE ATTACHMENT METHOD

The most common way of attaching a Microtag is via a nylon cable tie threaded through the slots located at the head and foot of the tag. The Microtag slots are also large enough to accommodate Brady recommended steel cable ties. If attachment via the slot system isn't an option, then adhesive strips can be fitted to the back of the tags. [See page 30 for more details.](#)

NANOTAG™ FOR ELECTRICAL EQUIPMENT

Nanotag for Electrical Equipment is designed to clearly display the Next Inspection Date Due / Next Test Date at the point of use.

- A selection of coloured inserts are available providing the option of additional visual qualification
- NAN GP insert records the Next Test

Holder

- **Material:** Nylon 6
- **Temperature Range:** -20 °C to +80 °C
- **Attachment Method:** Split Ring, Cable Tie
- **Extra Feature:** Embedded RFID chip as standard



Insert

- **Material:** Polypropylene
- **Temperature Range:** -10 °C to +90 °C
- **Design:** Identical both sides



Please turn to [page 34](#) for a Nanotag how to use guide.



Article No.	Order Reference	Description	Text/Legend	Colour	Height (mm)	Width (mm)	Packaging
Holders Only							
833302	NAN-NAN-A	Nanotag Holder		Red on White	54.00	26.00	20 Nanotag Holders, 40 Cable Ties (150mm), 1 Pen
Inserts Only							
833303	NAN-NAN-GP-OR-20	Nanotag Insert	Next Test Date	White on Orange	34.00	18.00	20 Nanotag Inserts
833304	NAN-NAN-GP-YL-20	Nanotag Insert	Next Test Date	Black on Yellow	34.00	18.00	20 Nanotag Inserts
833305	NAN-NAN-GP-BL-20	Nanotag Insert	Next Test Date	White on Blue	34.00	18.00	20 Nanotag Inserts
833306	NAN-NAN-GP-GN-20	Nanotag Insert	Next Test Date	White on Green	34.00	18.00	20 Nanotag Inserts
833307	NAN-NAN-GP-RD-20	Nanotag Insert	Next Test Date	White on Red	34.00	18.00	20 Nanotag Inserts
833308	NAN-NAN-GP-WH-20	Nanotag Insert	Next Test Date	Black on White	34.00	18.00	20 Nanotag Inserts
833309	NAN-NAN-GP-PL-20	Nanotag Insert	Next Test Date	White on Purple	34.00	18.00	20 Nanotag Inserts
Kits - Holders & Inserts							
833310	NAN-PK-GP-BL	Nanotag Kit	Next Test Date	White on Blue	-	-	20 Nanotag Holders, 20 Nanotag Inserts, 1 Pen
833311	NAN-PK-GP-PL	Nanotag Kit	Next Test Date	White on Purple	-	-	20 Nanotag Holders, 20 Nanotag Inserts, 1 Pen
833312	NAN-PK-GP-YL	Nanotag Kit	Next Test Date	Black on Yellow	-	-	20 Nanotag Holders, 20 Nanotag Inserts, 1 Pen
833313	NAN-PK-GP-GN	Nanotag Kit	Next Test Date	White on Green	-	-	20 Nanotag Holders, 20 Nanotag Inserts, 1 Pen
833314	NAN-PK-GP-OR	Nanotag Kit	Next Test Date	White on Orange	-	-	20 Nanotag Holders, 20 Nanotag Inserts, 1 Pen
833315	NAN-PK-GP-RD	Nanotag Kit	Next Test Date	White on Red	-	-	20 Nanotag Holders, 20 Nanotag Inserts, 1 Pen
833316	NAN-PK-GP-WH	Nanotag Kit	Next Test Date	Black on White	-	-	20 Nanotag Holders, 20 Nanotag Inserts, 1 Pen

The **Brady Visual Tagging Solutions** illustrated in this catalogue are available in a variety of languages. For the product order codes corresponding to the relevant languages, please turn to [pages 40 to 45](#).



UNITAG® FOR ELECTRICAL EQUIPMENT

Unitag for Electrical Equipment is designed to clearly display the Next Inspection Date Due / Next Test Date at the point of use.

- A selection of coloured inserts are available providing the option of additional visual qualification
- UNI GP insert records the Next Test Date
- Unitag holders supplied with Nylon, Stainless Steel or Plastic Wire Coated Strop attachments

Holder

- **Material:** Nylon 6
- **Temperature Range:** -20 °C to +80 °C
- **Attachment Method:** Strop

Insert

- **Material:** Polypropylene
- **Temperature Range:** -10 °C to +90 °C
- **Design:** Identical both sides



Please turn to [page 35](#) for a Unitag how to use guide.



Article No.	Order Reference	Description	Text/Legend	Colour	Diameter (mm)	Packaging
Holders Only						
806787	UNI-UNH-6-SS-A	Unitag Holder	Do Not Use	Red on White	50.00	20 Unitag Holders, 20 Stainless Steel Stropps (150mm), 1 Pen
832718	UNI-UNH-6-A	Unitag Holder	Do Not Use	Red on White	50.00	20 Unitag Holders, 20 Nylon Stropps (150mm), 1 Pen
832720	UNI-UNH-6-PC-A	Unitag Holder	Do Not Use	Red on White	50.00	20 Unitag Holders, 20 Plastic Coated Wire Stropps (150mm), 1 Pen
832721	UNI-UNH-9-A	Unitag Holder	Do Not Use	Red on White	50.00	20 Unitag Holders, 20 Nylon Stropps (225mm), 1 Pen
832722	UNI-UNH-9-SS-A	Unitag Holder	Do Not Use	Red on White	50.00	20 Unitag Holders, 20 Stainless Steel Stropps (225mm), 1 Pen
832723	UNI-UNH-9-PC-A	Unitag Holder	Do Not Use	Red on White	50.00	20 Unitag Holders, 20 Plastic Coated Wire Stropps (225mm), 1 Pen
832724	UNI-UNH-12-A	Unitag Holder	Do Not Use	Red on White	50.00	20 Unitag Holders, 20 Nylon Stropps (300mm), 1 Pen
Inserts Only						
832747	UNI-UNI-GP-RD-20	Unitag Insert	Next Test Date	White on Red	41.00	20 Unitag Inserts
832748	UNI-UNI-GP-BL-20	Unitag Insert	Next Test Date	White on Blue	41.00	20 Unitag Inserts
832749	UNI-UNI-GP-GN-20	Unitag Insert	Next Test Date	White on Green	41.00	20 Unitag Inserts
832750	UNI-UNI-GP-OR-20	Unitag Insert	Next Test Date	White on Orange	41.00	20 Unitag Inserts
832751	UNI-UNI-GP-PL-20	Unitag Insert	Next Test Date	White on Purple	41.00	20 Unitag Inserts
832752	UNI-UNI-GP-WH-20	Unitag Insert	Next Test Date	Black on White	41.00	20 Unitag Inserts
832753	UNI-UNI-GP-YL-20	Unitag Insert	Next Test Date	Black on Yellow	41.00	20 Unitag Inserts
Kits - Holders & Inserts						
832754	UNI-PK-GP-YL	Unitag Kit	Next Test Date	Black on Yellow	-	20 Unitag Holders, 20 Nylon Stropps (225mm), 20 Unitag Inserts
832755	UNI-PK-GP-GN	Unitag Kit	Next Test Date	White on Green	-	20 Unitag Holders, 20 Nylon Stropps (225mm), 20 Unitag Inserts
832756	UNI-PK-GP-RD	Unitag Kit	Next Test Date	White on Red	-	20 Unitag Holders, 20 Nylon Stropps (225mm), 20 Unitag Inserts
832757	UNI-PK-GP-WH	Unitag Kit	Next Test Date	Black on White	-	20 Unitag Holders, 20 Nylon Stropps (225mm), 20 Unitag Inserts
832758	UNI-PK-GP-BL	Unitag Kit	Next Test Date	White on Blue	-	20 Unitag Holders, 20 Nylon Stropps (225mm), 20 Unitag Inserts
832759	UNI-PK-GP-PL	Unitag Kit	Next Test Date	White on Purple	-	20 Unitag Holders, 20 Nylon Stropps (225mm), 20 Unitag Inserts
832760	UNI-PK-GP-OR	Unitag Kit	Next Test Date	White on Orange	-	20 Unitag Holders, 20 Nylon Stropps (225mm), 20 Unitag Inserts



KEEP YOUR TAGS ATTACHED

For attachment, Unitag comes with plastic nylon or plastic coated wire stropps as standard. If a more durable attachment is required, stainless steel stropps can be added as an option.



MICROTAG® FOR HAVs - VIBRATION/NOISE

Microtag for Hand Arm Vibration is designed to record exposure to vibration and noise levels and inform the operator of the equipment at the point of use.

- Record Tool ID, Test Date, Vibration Magnitude, Max. Daily Use and Noise Level
- A selection of coloured inserts are available providing the option of additional visual qualification

Holder

- **Material:** Nylon 6
- **Temperature Range:** -20 °C to +80 °C
- **Attachment Method:** Cable Tie, Adhesive Strip

Insert

- **Material:** Polypropylene
- **Temperature Range:** -10 °C to +90 °C
- **Design:** Identical both sides



Please turn to [page 35](#) for a Microtag how to use guide.

Article No.	Order Reference	Description	Text/Legend	Colour	Height (mm)	Width (mm)	Packaging
Holders Only							
831979	MIC-MTH-BARCODE-A	Microtag Barcode Holder	Do Not Use Equipment	Red on White	81.00	38.00	20 Microtag Bar-Code Holders, 40 Cable Ties (150mm), 1 Pen
806723	MIC-MTH-A	Microtag Holder	Do Not Use Equipment	Red on White	81.00	38.00	20 Microtag Holders, 40 Cable Ties (150mm), 1 Pen
Inserts Only							
832022	MIC-MTI-405-PL-20	Microtag Insert	Vibration - Noise Level	White on Purple	47.00	30.00	20 Microtag Inserts
832023	MIC-MTI-405-OR-20	Microtag Insert	Vibration - Noise Level	White on Orange	47.00	30.00	20 Microtag Inserts
832024	MIC-MTI-405-YL-20	Microtag Insert	Vibration - Noise Level	Black on Yellow	47.00	30.00	20 Microtag Inserts
832025	MIC-MTI-405-BL-20	Microtag Insert	Vibration - Noise Level	White on Blue	47.00	30.00	20 Microtag Inserts
832026	MIC-MTI-405-RD-20	Microtag Insert	Vibration - Noise Level	White on Red	47.00	30.00	20 Microtag Inserts
832027	MIC-MTI-405-GN-20	Microtag Insert	Vibration - Noise Level	White on Green	47.00	30.00	20 Microtag Inserts
832028	MIC-MTI-405-WH-20	Microtag Insert	Vibration - Noise Level	Black on White	47.00	30.00	20 Microtag Inserts
Kits - Holders & Inserts							
832029	MIC-PK-MTI-405-BL	Microtag Kit	Vibration - Noise Level	White on Blue	-	-	20 Microtag Holders, 20 Microtag Inserts, 1 Pen
832030	MIC-PK-MTI-405-GN	Microtag Kit	Vibration - Noise Level	White on Green	-	-	20 Microtag Holders, 20 Microtag Inserts, 1 Pen
832031	MIC-PK-MTI-405-OR	Microtag Kit	Vibration - Noise Level	White on Orange	-	-	20 Microtag Holders, 20 Microtag Inserts, 1 Pen
832032	MIC-PK-MTI-405-RD	Microtag Kit	Vibration - Noise Level	White on Red	-	-	20 Microtag Holders, 20 Microtag Inserts, 1 Pen
832033	MIC-PK-MTI-405-YL	Microtag Kit	Vibration - Noise Level	Black on Yellow	-	-	20 Microtag Holders, 20 Microtag Inserts, 1 Pen
832034	MIC-PK-MTI-405-WH	Microtag Kit	Vibration - Noise Level	Black on White	-	-	20 Microtag Holders, 20 Microtag Inserts, 1 Pen
832035	MIC-PK-MTI-405-PL	Microtag Kit	Vibration - Noise Level	White on Purple	-	-	20 Microtag Holders, 20 Microtag Inserts, 1 Pen

The **Brady Visual Tagging Solutions** illustrated in this catalogue are available in a variety of languages.

For the product order codes corresponding to the relevant languages, please turn to [pages 40 to 45](#).



English



German



French



Dutch



Norwegian



Finnish



Swedish



Turkish



Russian



Danish

MICROTAG® FOR HAVs - VIBRATION/POINTS SYSTEM

Microtag for Hand Arm Vibration is designed to record exposure to vibration and points per hour.

- Record Tool ID, Test Date, Vibration Magnitude, Max. Daily Use, Points per Hour
- A selection of coloured inserts are available providing the option of additional visual qualification



Holder

- **Material:** Nylon 6
- **Temperature Range:** -20 °C to +80 °C
- **Attachment Method:** Cable Tie, Adhesive Strip

Insert

- **Material:** Polypropylene
- **Temperature Range:** -10 °C to +90 °C
- **Design:** Identical both sides



Please turn to [page 35](#) for a Microtag how to use guide.

Article No.	Order Reference	Description	Text/Legend	Colour	Height (mm)	Width (mm)	Packaging
Holders Only							
831979	MIC-MTH-BARCODE-A	Microtag Barcode Holder	Do Not Use Equipment	Red on White	81.00	38.00	20 Microtag Bar-Code Holders, 40 Cable Ties (150mm), 1 Pen
806723	MIC-MTH-A	Microtag Holder	Do Not Use Equipment	Red on White	81.00	38.00	20 Microtag Holders, 40 Cable Ties (150mm), 1 Pen
Inserts Only							
832036	MIC-MTI-451-PL-20	Microtag Insert	Vibration - Points Per Hour	White on Purple	47.00	30.00	20 Microtag Inserts
832037	MIC-MTI-451-GN-20	Microtag Insert	Vibration - Points Per Hour	White on Green	47.00	30.00	20 Microtag Inserts
832038	MIC-MTI-451-BL-20	Microtag Insert	Vibration - Points Per Hour	White on Blue	47.00	30.00	20 Microtag Inserts
832039	MIC-MTI-451-YL-20	Microtag Insert	Vibration - Points Per Hour	Black on Yellow	47.00	30.00	20 Microtag Inserts
832040	MIC-MTI-451-RD-20	Microtag Insert	Vibration - Points Per Hour	White on Red	47.00	30.00	20 Microtag Inserts
832041	MIC-MTI-451-OR-20	Microtag Insert	Vibration - Points Per Hour	White on Orange	47.00	30.00	20 Microtag Inserts
Kits - Holders & Inserts							
832042	MIC-MTI-451-WH-20	Microtag Insert	Vibration - Points Per Hour	Black on White	47.00	30.00	20 Microtag Inserts
832043	MIC-PK-MTI-451-OR	Microtag Kit	Vibration - Points Per Hour	White on Orange	-	-	20 Microtag Holders, 20 Microtag Inserts, 1 Pen
832044	MIC-PK-MTI-451-GN	Microtag Kit	Vibration - Points Per Hour	White on Green	-	-	20 Microtag Holders, 20 Microtag Inserts, 1 Pen
832045	MIC-PK-MTI-451-RD	Microtag Kit	Vibration - Points Per Hour	White on Red	-	-	20 Microtag Holders, 20 Microtag Inserts, 1 Pen
832046	MIC-PK-MTI-451-YL	Microtag Kit	Vibration - Points Per Hour	Black on Yellow	-	-	20 Microtag Holders, 20 Microtag Inserts, 1 Pen
832047	MIC-PK-MTI-451-BL	Microtag Kit	Vibration - Points Per Hour	White on Blue	-	-	20 Microtag Holders, 20 Microtag Inserts, 1 Pen
832048	MIC-PK-MTI-451-PL	Microtag Kit	Vibration - Points Per Hour	White on Purple	-	-	20 Microtag Holders, 20 Microtag Inserts, 1 Pen
832049	MIC-PK-MTI-451-WH	Microtag Kit	Vibration - Points Per Hour	Black on White	-	-	20 Microtag Holders, 20 Microtag Inserts, 1 Pen

NANOTAG™ FOR FIRE AND EMERGENCY EQUIPMENT

Nanotag for Fire and Emergency Equipment is designed to clearly display the Next Inspection Date Due at the point of use.

- A selection of coloured inserts are available providing the option of additional visual qualification
- NAN GPI insert records Next Inspection Date Due and equipment reference number

Holder

- **Material:** Nylon 6
- **Temperature Range:** -20 °C to +80 °C
- **Attachment Method:** Split Ring, Cable Tie
- **Extra Feature:** Embedded RFID chip as standard

Insert

- **Material:** Polypropylene
- **Temperature Range:** -10 °C to +90 °C
- **Design:** Identical both sides



Please turn to **page 34** for a Nanotag how to use guide.

Article No.	Order Reference	Description	Text/Legend	Colour	Height (mm)	Width (mm)	Packaging
Holders Only							
833302	NAN-NAN-A	Nanotag Holder		Red on White	54.00	26.00	20 Nanotag Holders, 40 Cable Ties (150mm), 1 Pen
Inserts Only							
833317	NAN-NAN-GPI-YL-20	Nanotag Insert	Next Inspection Date Due	Black on Yellow	34.00	18.00	20 Nanotag Inserts
833318	NAN-NAN-GPI-OR-20	Nanotag Insert	Next Inspection Date Due	White on Orange	34.00	18.00	20 Nanotag Inserts
833319	NAN-NAN-GPI-RD-20	Nanotag Insert	Next Inspection Date Due	White on Red	34.00	18.00	20 Nanotag Inserts
833320	NAN-NAN-GPI-BL-20	Nanotag Insert	Next Inspection Date Due	White on Blue	34.00	18.00	20 Nanotag Inserts
833321	NAN-NAN-GPI-GN-20	Nanotag Insert	Next Inspection Date Due	White on Green	34.00	18.00	20 Nanotag Inserts
833322	NAN-NAN-GPI-PL-20	Nanotag Insert	Next Inspection Date Due	White on Purple	34.00	18.00	20 Nanotag Inserts
833323	NAN-NAN-GPI-WH-20	Nanotag Insert	Next Inspection Date Due	Black on White	34.00	18.00	20 Nanotag Inserts
Kits - Holders & Inserts							
833324	NAN-PK-GPI-PL	Nanotag Kit	Next Inspection Date Due	White on Purple	-	-	20 Nanotag Holders, 20 Nanotag Inserts, 1 Pen
833325	NAN-PK-GPI-BL	Nanotag Kit	Next Inspection Date Due	White on Blue	-	-	20 Nanotag Holders, 20 Nanotag Inserts, 1 Pen
833326	NAN-PK-GPI-GN	Nanotag Kit	Next Inspection Date Due	White on Green	-	-	20 Nanotag Holders, 20 Nanotag Inserts, 1 Pen
833327	NAN-PK-GPI-RD	Nanotag Kit	Next Inspection Date Due	White on Red	-	-	20 Nanotag Holders, 20 Nanotag Inserts, 1 Pen
833328	NAN-PK-GPI-OR	Nanotag Kit	Next Inspection Date Due	White on Orange	-	-	20 Nanotag Holders, 20 Nanotag Inserts, 1 Pen
833329	NAN-PK-GPI-WH	Nanotag Kit	Next Inspection Date Due	Black on White	-	-	20 Nanotag Holders, 20 Nanotag Inserts, 1 Pen
833330	NAN-PK-GPI-YL	Nanotag Kit	Next Inspection Date Due	Black on Yellow	-	-	20 Nanotag Holders, 20 Nanotag Inserts, 1 Pen

The **Brady Visual Tagging Solutions** illustrated in this catalogue are available in a variety of languages. For the product order codes corresponding to the relevant languages, please turn to **pages 40 to 45**.



English



German



French



Dutch



Norwegian



Finnish



Swedish



Turkish



Russian



Danish



SCAFFTAG® MK1

The world leading Visual Tagging System for scaffolding to help prevent working at height hazards and manage scaffolding inspection procedures.

- A Scafftag should be fitted at all access points (normally ladder access) from first build stage and remain on the structure until dismantle
- Record all important details relating to the scaffolding build
- Record the signature, time and date of up to 12 inspections per insert
- Holder loop compatible with both Tube and Clip and System scaffolding

Holder

- **Material:** Nylon 6
- **Temperature Range:** -20 °C to +80 °C
- **Attachment Method:** Hung, Cable Tie

Insert

- **Material:** Polypropylene
- **Temperature Range:** -10 °C to +90 °C



Please turn to [page 37](#) for a Scafftag how to use guide.



Article No.	Order Reference	Description	Height (mm)	Width (mm)	Packaging
Holders Only					
831415	SCAF-STH-A	Scafftag MK1 Holder	356.00	91.00	10 Scafftag MK1 Holders, 1 Pen
Inserts Only					
806759	SCAF-STSI-STD-50	Scafftag MK1 Insert	208.00	85.00	50 Scafftag MK1 Inserts
831418	SCAF-STSI-STD-10	Scafftag MK1 Insert	208.00	85.00	10 Scafftag MK1 Inserts
831419	SCAF-STSI-STD-20	Scafftag MK1 Insert	208.00	85.00	20 Scafftag MK1 Inserts
Kits - Holders & Inserts					
806755	SCAF-STSH-A	Scafftag MK1 Kit	-	-	10 Scafftag MK1 Holders, 20 Scafftag MK1 Inserts, 1 Pen

SCAFFTAG® MK2

Scafftag MK2 is a larger version of our standard scaffolding tag. The holder is larger with more inspection records available on the insert (22). Scafftag MK2 helps prevent working at height hazards and manage scaffolding inspection procedures.

- A Scafftag should be fitted at all access points (normally ladder access) from first build stage and remain on the structure until dismantle
- Record all important details relating to the scaffolding build
- Record the signature, time and date of upto 22 inspections per insert
- Holder loop compatible with both Tube and Clip and System scaffolding

Holder

- **Material:** Nylon 6
- **Temperature Range:** -20 °C to +80 °C
- **Attachment Method:** Hung, Cable Tie

Insert

- **Material:** Polypropylene
- **Temperature Range:** -10 °C to +90 °C

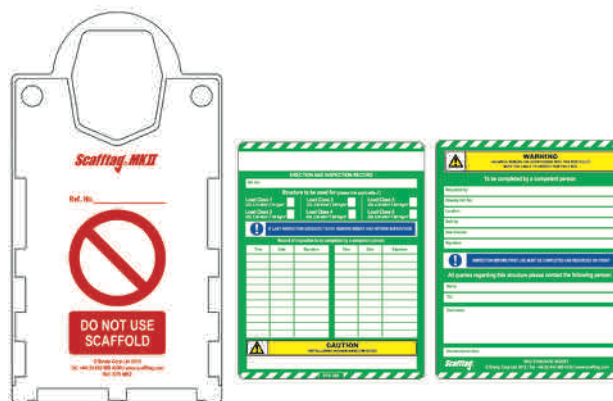

Article No.	Order Reference	Description	Height (mm)	Width (mm)	Packaging
Holders Only					
833754	STH 2	Scafftag MK2 Holder	285.00	151.00	10 Scafftag MK2 Holders, 1 Pen
Inserts Only					
833756	STSI 369 ETS	Scafftag MK2 Insert	193.00	144.00	10 Scafftag MK2 Inserts
Kits - Holders & Inserts					
833755	STSH MK2	Scafftag MK2 Kit	-	-	10 Scafftag MK2 Holders, 20 Scafftag MK2 Inserts, 1 Pen

SCAFFOLDING SPECIAL STATUS INSERTS

Special Status Inserts are designed to operate with Scafftag holders and provide a visual warning to users that the scaffold is not to be used.

Insert

- Material: Polypropylene
- Temperature Range: -10 °C to +90 °C



Legend:
Awaiting Dismantle Do Not Use Scaffold

Legend:
Scaffold Not To Be Used Beyond This Point

Article No.	Order Reference	Description	Text/Legend	Height (mm)	Width (mm)	Packaging
831425	SCAF-STSI-PD-10	Special Status Insert	Awaiting Dismantle Do Not Use Scaffold	208.00	85.00	10 Special Status Inserts
831427	SCAF-STSI-S22-10	Special Status Insert	Scaffold Not To Be Used Beyond This Point	208.00	85.00	10 Special Status Inserts

SCAFFOLDING PROHIBITION INSERTS

Scaffolding Prohibition Inserts are designed to operate with Scafftag holders helping to identify working at height hazards and efficiently manage inspection procedures.

- Clearly identify at access point the reasons why the scaffolding has been found unsafe to use

MK 1 Insert

- Material: Polypropylene
- Temperature Range: -10 °C to +90 °C

MK2 Insert

- Material: Polypropylene
- Temperature Range: -10 °C to +90 °C



SCAFF-STSI-PRO-10

STSI-P-ETS

Article No.	Order Reference	Description	Height (mm)	Width (mm)	Packaging
831429	SCAF-STSI-PRO-10	Prohibition MK1 Insert	208.00	85.00	10 Prohibition MK1 Inserts
833757	STSI-P-ETS	Prohibition MK2 Insert	193.00	144.00	10 Prohibition MK2 Inserts

STRUCTURAL TIE TAGS

Structural Tie Tags provide a visual warning of the latest Tie Tests.

Structural Tie Test Tag

Records the Tie Test Date, Test Load Applied, Required Tensile Strength and a unique number for ongoing monitoring.

Structural Tie Warning Tag

A prohibition tag for structural ties that have not been tested.

- Material: Polypropylene
- Temperature Range: -10 °C to +90 °C



Legend:
Do Not Remove This Tie Or Tag

Legend:
Do Not Remove Scaffold Tie



Article No.	Order Reference	Description	Text/Legend	Height (mm)	Width (mm)	Packaging
831436	SUND-MISC-189-50	Structural Tie Test Tag	Do Not Remove This Tie Or Tag	150.00	80.00	50 Structural Tie Test Tags
831437	SUND-MISC-190-50	Structural Tie Warning Tags	Do Not Remove Scaffold Tie	150.00	80.00	50 Structural Tie Warning Tags

The **Brady Visual Tagging Solutions** illustrated in this catalogue are available in a variety of languages.

For the product order codes corresponding to the relevant languages, please turn to **pages 40 to 45**.



English



German



French



Dutch



Norwegian



Finnish



Swedish



Turkish



Russian



Danish



SCAFFOLD QUARANTINE TAG

Quickly leave equipment, tools or scaffold in prohibition and clearly communicate who did it and why. Quarantine Tag is a great source of safety communication and compliance in the workplace.

Write in the comments box, wrap it around the asset and pull off the paper strip, revealing a see through sticky strip - it then seals in the text; hangs like a flag, showing 'quarantined' on one side and the details on the other.

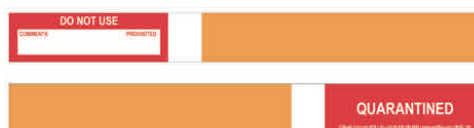

Article No.	Order Reference	Description	Height (mm)	Width (mm)	Packaging
833753	MISC 160	Quarantine Tag	40.00	37.00	50 Quarantine Strip Tags



TOWERTAG®

Towertag is designed to display Mobile Tower safe working loads (SWL), movement references and inspection data at the point of use.

- Make information regarding the mobile towers build easily available
- Record up to 8 Mobile Tower movements
- Up to 10 records of inspections

Holder

- **Material:** Nylon 6
- **Temperature Range:** -20 °C to +80 °C
- **Attachment Method:** Hung, Cable Tie

Insert

- **Material:** Polypropylene
- **Temperature Range:** -10 °C to +90 °C



Please turn to **page 38** for a Towertag how to use guide.

Article No.	Order Reference	Description	Height (mm)	Width (mm)	Packaging
Holders Only					
831417	SCAF-STH-368-SLIT-A	Towertag Holders	356.00	91.00	10 Towertag Holders
Inserts Only					
831422	SCAF-STSI-368-STD-10	Towertag Insert	208.00	85.00	10 Towertag Inserts
831423	SCAF-STSI-368-STD-20	Towertag Insert	208.00	85.00	20 Towertag Inserts
831424	SCAF-STSI-368-STD-50	Towertag Insert	208.00	85.00	50 Towertag Inserts
Kits - Holders & Inserts					
831416	SCAF-STSH-368-SLIT-A	Towertag Kit	-	-	10 Towertag Holders, 20 Towertag Inserts, 1 Pen

LADDERTAG®

Laddertag displays the latest information relating to a ladders class, inspection period and inspections due.

- Record unique ladder reference number, intended ladder use, risk assessment period and inspections due
- Record up to 12 ladder inspection due dates
- Laddertag insert contains pre-use checklist

Holder

- **Material:** Polycarbonate
- **Temperature Range:** -20 °C to +130 °C
- **Attachment Method:** Cable Tie, Adhesive Strip

Insert

- **Material:** Polypropylene
- **Temperature Range:** -10 °C to +90 °C



Please turn to **page 37** for a Laddertag how to use guide.

Article No.	Order Reference	Description	Height (mm)	Width (mm)	Packaging
Holders Only					
831850	LAD-GB-EITH-12-A	Ladders Holder	210.00	55.00	10 Laddertag Holders
Inserts Only					
806715	LAD-GB-EITL-12-50	Ladders Insert	164.00	50.00	50 Laddertag Inserts
806719	LAD-GB-EITL-12-10	Ladders Insert	164.00	50.00	10 Laddertag Inserts
Kits - Holders & Inserts					
806711	LAD-GB-EITH-L12-A	Laddertag Kit	-	-	10 Laddertag Holders, 10 Laddertag Inserts, 1 Pen



FUTURE-PROOF YOUR TAGGING SYSTEMS WITH RFID TECHNOLOGY

RFID chips can be added to Laddertag on request and the option of including the technology in other Brady tags, from Microtag to Scaffoldtag, is also available. For information on future-proofing your Brady Visual Tagging Solutions with RFID technology, contact your nearest customer services department. **Contacts for Brady customer services are listed on the back cover of this catalogue.**



The **Brady Visual Tagging Solutions** illustrated in this catalogue are available in a variety of languages. For the product order codes corresponding to the relevant languages, please turn to **pages 40 to 45**.



MICROTAG® FOR STEPS AND STOOLS

Microtag for Steps & Stools is designed to clearly display the Next Inspection Date Due at the point of use.

- A selection of coloured inserts are available providing the option of additional visual qualification
- A barcoded Microtag holder is also available

Holder

- **Material:** Nylon 6
- **Temperature Range:** -20 °C to +80 °C
- **Attachment Method:** Cable Tie, Adhesive Strip

Insert

- **Material:** Polypropylene
- **Temperature Range:** -10 °C to +90 °C
- **Design:** Identical both sides



i Please turn to [page 35](#) for a Microtag how to use guide.



Article No.	Order Reference	Description	Text/Legend	Colour	Height (mm)	Width (mm)	Packaging
Holders Only							
831979	MIC-MTH-BARCODE-A	Microtag Barcode Holder	Do Not Use Equipment	Red on White	81.00	38.00	20 Microtag Bar-Code Holders, 40 Cable Ties (150mm), 1 Pen
806723	MIC-MTH-A	Microtag Holder	Do Not Use Equipment	Red on White	81.00	38.00	20 Microtag Holders, 40 Cable Ties (150mm), 1 Pen
Inserts Only							
806731	MIC-MTI-GPI-RD-20	Microtag Insert	Next Inspection Date Due	White on Red	47.00	30.00	20 Microtag Inserts
806735	MIC-MTI-GPI-YL-20	Microtag Insert	Next Inspection Date Due	Black on Yellow	47.00	30.00	20 Microtag Inserts
832008	MIC-MTI-GPI-BL-20	Microtag Insert	Next Inspection Date Due	White on Blue	47.00	30.00	20 Microtag Inserts
832009	MIC-MTI-GPI-GN-20	Microtag Insert	Next Inspection Date Due	White on Green	47.00	30.00	20 Microtag Inserts
832010	MIC-MTI-GPI-OR-20	Microtag Insert	Next Inspection Date Due	White on Orange	47.00	30.00	20 Microtag Inserts
832011	MIC-MTI-GPI-PL-20	Microtag Insert	Next Inspection Date Due	White on Purple	47.00	30.00	20 Microtag Inserts
832012	MIC-MTI-GPI-WH-20	Microtag Insert	Next Inspection Date Due	Black on White	47.00	30.00	20 Microtag Inserts
Kits - Holders & Inserts							
832015	MIC-PK-GPI-YL	Microtag Kit	Next Inspection Date Due	Black on Yellow	-	-	20 Microtag Holders, 20 Microtag Inserts, 1 Pen
832016	MIC-PK-GPI-PL	Microtag Kit	Next Inspection Date Due	White on Purple	-	-	20 Microtag Holders, 20 Microtag Inserts, 1 Pen
832017	MIC-PK-GPI-WH	Microtag Kit	Next Inspection Date Due	Black on White	-	-	20 Microtag Holders, 20 Microtag Inserts, 1 Pen
832018	MIC-PK-GPI-RD	Microtag Kit	Next Inspection Date Due	White on Red	-	-	20 Microtag Holders, 20 Microtag Inserts, 1 Pen
832019	MIC-PK-GPI-OR	Microtag Kit	Next Inspection Date Due	White on Orange	-	-	20 Microtag Holders, 20 Microtag Inserts, 1 Pen
832020	MIC-PK-GPI-GN	Microtag Kit	Next Inspection Date Due	White on Green	-	-	20 Microtag Holders, 20 Microtag Inserts, 1 Pen
832021	MIC-PK-GPI-BL	Microtag Kit	Next Inspection Date Due	White on Blue	-	-	20 Microtag Holders, 20 Microtag Inserts, 1 Pen

NANOTAG™ FOR STEPS AND STOOLS

Nanotag for Steps & Stools is designed to clearly display the Next Inspection Date Due at the point of use.

- A selection of coloured inserts are available providing the option of additional visual qualification

Holder

- **Material:** Nylon 6
- **Temperature Range:** -20 °C to +80 °C
- **Attachment Method:** Split Ring, Cable Tie
- **Extra Feature:** Embedded RFID chip as standard

Insert

- **Material:** Polypropylene
- **Temperature Range:** -10 °C to +90 °C
- **Design:** Identical both sides



Please turn to **page 34** for a Nanotag how to use guide.



Article No.	Order Reference	Description	Text/Legend	Colour	Height (mm)	Width (mm)	Packaging
Holders Only							
833302	NAN-NAN-A	Nanotag Holder		Red on White	54.00	26.00	20 Nanotag Holders, 40 Cable Ties (150mm), 1 Pen
Inserts Only							
833317	NAN-NAN-GPI-YL-20	Nanotag Insert	Next Inspection Date Due	Black on Yellow	34.00	18.00	20 Nanotag Inserts
833318	NAN-NAN-GPI-OR-20	Nanotag Insert	Next Inspection Date Due	White on Orange	34.00	18.00	20 Nanotag Inserts
833319	NAN-NAN-GPI-RD-20	Nanotag Insert	Next Inspection Date Due	White on Red	34.00	18.00	20 Nanotag Inserts
833320	NAN-NAN-GPI-BL-20	Nanotag Insert	Next Inspection Date Due	White on Blue	34.00	18.00	20 Nanotag Inserts
833321	NAN-NAN-GPI-GN-20	Nanotag Insert	Next Inspection Date Due	White on Green	34.00	18.00	20 Nanotag Inserts
833322	NAN-NAN-GPI-PL-20	Nanotag Insert	Next Inspection Date Due	White on Purple	34.00	18.00	20 Nanotag Inserts
833323	NAN-NAN-GPI-WH-20	Nanotag Insert	Next Inspection Date Due	Black on White	34.00	18.00	20 Nanotag Inserts
Kits - Holders & Inserts							
833324	NAN-PK-GPI-PL	Nanotag Kit	Next Inspection Date Due	White on Purple	-	-	20 Nanotag Holders, 20 Nanotag Inserts, 1 Pen
833325	NAN-PK-GPI-BL	Nanotag Kit	Next Inspection Date Due	White on Blue	-	-	20 Nanotag Holders, 20 Nanotag Inserts, 1 Pen
833326	NAN-PK-GPI-GN	Nanotag Kit	Next Inspection Date Due	White on Green	-	-	20 Nanotag Holders, 20 Nanotag Inserts, 1 Pen
833327	NAN-PK-GPI-RD	Nanotag Kit	Next Inspection Date Due	White on Red	-	-	20 Nanotag Holders, 20 Nanotag Inserts, 1 Pen
833328	NAN-PK-GPI-OR	Nanotag Kit	Next Inspection Date Due	White on Orange	-	-	20 Nanotag Holders, 20 Nanotag Inserts, 1 Pen
833329	NAN-PK-GPI-WH	Nanotag Kit	Next Inspection Date Due	Black on White	-	-	20 Nanotag Holders, 20 Nanotag Inserts, 1 Pen
833330	NAN-PK-GPI-YL	Nanotag Kit	Next Inspection Date Due	Black on Yellow	-	-	20 Nanotag Holders, 20 Nanotag Inserts, 1 Pen

The **Brady Visual Tagging Solutions** illustrated in this catalogue are available in a variety of languages. For the product order codes corresponding to the relevant languages, please turn to **pages 40 to 45**.





NANOTAG™ FOR HARNESS

Nanotag for harnesses is designed to clearly display the Next Inspection Date Due at the point of use.

- A selection of coloured inserts are available providing the option of additional visual qualification

Holder

- **Material:** Nylon 6
- **Temperature Range:** -20 °C to +80 °C
- **Attachment Method:** Split Ring, Cable Tie
- **Extra Feature:** Embedded RFID chip as standard

Insert

- **Material:** Polypropylene
- **Temperature Range:** -10 °C to +90 °C
- **Design:** Identical both sides



Please turn to [page 34](#) for a Nanotag how to use guide.

Article No.	Order Reference	Description	Text/Legend	Colour	Height (mm)	Width (mm)	Packaging
Holders Only							
833302	NAN-NAN-A	Nanotag Holder		Red on White	54.00	26.00	20 Nanotag Holders, 40 Cable Ties (150mm), 1 Pen
Inserts Only							
833317	NAN-NAN-GPI-YL-20	Nanotag Insert	Next Inspection Date Due	Black on Yellow	34.00	18.00	20 Nanotag Inserts
833318	NAN-NAN-GPI-OR-20	Nanotag Insert	Next Inspection Date Due	White on Orange	34.00	18.00	20 Nanotag Inserts
833319	NAN-NAN-GPI-RD-20	Nanotag Insert	Next Inspection Date Due	White on Red	34.00	18.00	20 Nanotag Inserts
833320	NAN-NAN-GPI-BL-20	Nanotag Insert	Next Inspection Date Due	White on Blue	34.00	18.00	20 Nanotag Inserts
833321	NAN-NAN-GPI-GN-20	Nanotag Insert	Next Inspection Date Due	White on Green	34.00	18.00	20 Nanotag Inserts
833322	NAN-NAN-GPI-PL-20	Nanotag Insert	Next Inspection Date Due	White on Purple	34.00	18.00	20 Nanotag Inserts
833323	NAN-NAN-GPI-WH-20	Nanotag Insert	Next Inspection Date Due	Black on White	34.00	18.00	20 Nanotag Inserts
Kits - Holders & Inserts							
833324	NAN-PK-GPI-PL	Nanotag Kit	Next Inspection Date Due	White on Purple	-	-	20 Nanotag Holders, 20 Nanotag Inserts, 1 Pen
833325	NAN-PK-GPI-BL	Nanotag Kit	Next Inspection Date Due	White on Blue	-	-	20 Nanotag Holders, 20 Nanotag Inserts, 1 Pen
833326	NAN-PK-GPI-GN	Nanotag Kit	Next Inspection Date Due	White on Green	-	-	20 Nanotag Holders, 20 Nanotag Inserts, 1 Pen
833327	NAN-PK-GPI-RD	Nanotag Kit	Next Inspection Date Due	White on Red	-	-	20 Nanotag Holders, 20 Nanotag Inserts, 1 Pen
833328	NAN-PK-GPI-OR	Nanotag Kit	Next Inspection Date Due	White on Orange	-	-	20 Nanotag Holders, 20 Nanotag Inserts, 1 Pen
833329	NAN-PK-GPI-WH	Nanotag Kit	Next Inspection Date Due	Black on White	-	-	20 Nanotag Holders, 20 Nanotag Inserts, 1 Pen
833330	NAN-PK-GPI-YL	Nanotag Kit	Next Inspection Date Due	Black on Yellow	-	-	20 Nanotag Holders, 20 Nanotag Inserts, 1 Pen

ENTRYTAG®

Entrytag is designed to help prevent accidents and efficiently manage inspection procedures within confined spaces.

- Record information relating to the confined space such as permit numbers, test dates, and safety equipment required
- Record up to 42 shift inspections
- Alternative Entrytag holder with magnetic attachment available

Holder

- **Material:** ABS (Acrylonitrile Butadiene Styrene) thermoplastic
- **Temperature Range:** -5 °C to +65 °C
- **Attachment Method:** Cable Tie, Adhesive Strip, Magnetic Strip

Insert

- **Material:** Polypropylene
- **Temperature Range:** -10 °C to +90 °C



Please turn to [page 38](#) for an Entrytag how to use guide.



Article No.	Order Reference	Description	Height (mm)	Width (mm)	Packaging
Holders Only					
136550	ENT-GB-ETSH-V2-A	Entrytag Holder	260.00	153.00	10 Entrytag Holders, 1 Pen
137994	ENT-GB-ETSH-V2-MAG-A	Entrytag Holder	260.00	153.00	10 Entrytag Holders (magnetic attachment)
Inserts Only					
831637	ENT-ETSI-STD-10	Entrytag Insert	193.00	144.00	10 Entrytag Inserts
831638	ENT-ETSI-STD-50	Entrytag Insert	193.00	144.00	50 Entrytag Inserts
Kits - Holders & Inserts					
136572	ENT-GB-ETI-V2-A	Entrytag Kit	-	-	10 Entrytag Holders, 10 Entrytag Inserts, 1 Pen

MAN IN...

Used in conjunction with Entrytag, each authorised person(s) has a dedicated Man in Confined Space or Man in Tank Tag (containing their details). The Man In Tag attaches to the Entrytag before entering a confined space, removing the tag when leaving.

By counting the number of Man in Tags at the point of entry, it is instantly clear how many people are working in the confined space.

- **Material:** Polypropylene
- **Temperature Range:** -10 °C to +90 °C



MUL-EITL-577 Man in Confined Space

MUL-EITL-529 Man in Tank

Article No.	Order Reference	Description	Height (mm)	Width (mm)	Packaging
831915	MUL-EITL-577	Man In Confined Space Tag	164.00	50.00	1 Tag
831916	MUL-EITL-529	Man In Tank Tag	164.00	50.00	1 Tag

The **Brady Visual Tagging Solutions** illustrated in this catalogue are available in a variety of languages.

For the product order codes corresponding to the relevant languages, please turn to [pages 40 to 45](#).



English



German



French



Dutch



Norwegian



Finnish



Swedish



Turkish



Russian



Danish

PERMIT WALLETS

Permit Document Wallets provide ultimate protection and ease of viewing of permits / documents at the point of use.

- UV and moisture resistant
- Transparent
- Easy access zip closure from top to bottom
- Available in A4 and A5 sizes



Article No.	Order Reference	Description	Packaging
833760	PW1	A4 Permit Wallets	Pack of 1
833761	PW2	A5 Permit Wallets	Pack of 1

PEN CLIP HOLDER

The Pen Clip Holder is unobtrusive (13 mm width) and suitable for attachment to Entrytag, Forklifttag, Chemtag and MEWP Tag.

The Pen Clip Holder attaches to the side of the holder to ensure you always have a suitable pen at hand while completing your inspection and maintenance checks.

Pens are not included, they must be ordered separately. The pen clip holders accommodate the Edding 141 F pen supplied as standard with certain products.

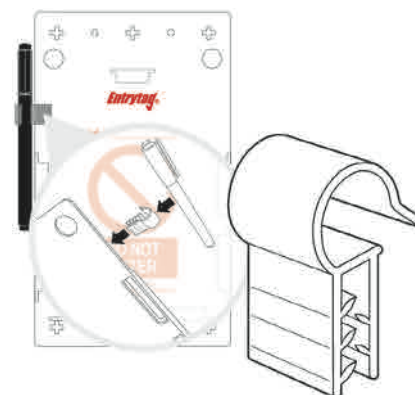

Article No.	Order Reference	Description	Packaging
833759	SUND-PENHOLDER	Pen Clip Holder	Pack of 10



CHEMTAG®

Chemtag is designed to identify hazardous substances as defined by COSHH (Control of Substances Hazardous to Health):2002. The Chemtag insert contains all the pertinent information specific to the risks that hazardous substances pose, such as:

- Substance type
- Details of hazards and precautions
- Action to be taken in case of emergency
- Supplier's name and emergency telephone number
- Details of how to dispose of the item

Holder

- **Material:** ABS (Acrylonitrile Butadiene Styrene) thermoplastic
- **Temperature Range:** -5 °C to +65 °C
- **Attachment Method:** Cable Tie, Adhesive Strip

Insert

- **Material:** Polypropylene
- **Temperature Range:** -10 °C to +90 °C



Please turn to **page 39** for a Chemtag how to use guide.

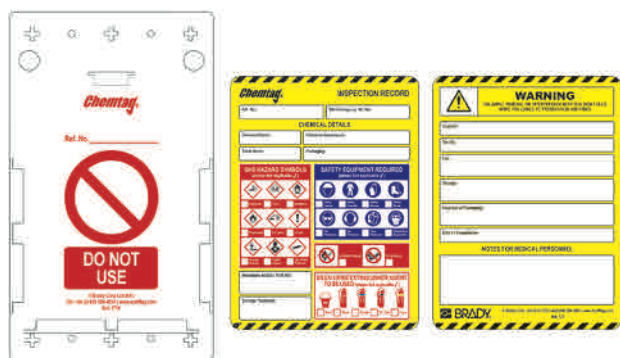

Article No.	Order Reference	Description	Height (mm)	Width (mm)	Packaging
Holders Only					
136504	CHEM-GB-CTH-V2-A	Chemtag Holder	260.00	153.00	10 Chemtag Holders
Inserts Only					
806683	CHEM-GB-CTI-STD-50	Chemtag Insert	193.00	144.00	50 Chemtag Inserts
806687	CHEM-GB-CTI-STD-10	Chemtag Insert	193.00	144.00	10 Chemtag Inserts
Kits - Holders & Inserts					
136526	CHEM-GB-CTSH-V2-A	Chemtag Kit	-	-	10 Chemtag Holders, 10 Chemtag Inserts, 1 Pen

FLANGE TAG

Flange Tag helps control inspection, modification and maintenance throughout the flange break / inspection process.

The system is three part perforated and assists the user to clearly identify the various stages of the operation from the initial break to the re-energisation of the system.

- Material: Polypropylene
- Temperature Range: -10 °C to +90 °C



STSI 522A Flange Tag

STSI 422DS Joint Tag



Article No.	Order Reference	Description	Height (mm)	Width (mm)	Packaging
833764	STSI 522A	3 Part Flange Tag	200.00	83.00	Pack of 10
833763	STSI 422DS	3 Part Joint Tag	200.00	83.00	Pack of 10

ISOLATION TAG

Isolation Tag is designed to help control mechanical and electrical isolation procedures and prevent inadvertent energising of the system.

Isolation Tag is a perforated tag and consists of two identical sections which are completed by the person in charge. The top half is attached to the isolation point, the bottom is removed and stapled to the Permit to Work. The isolation is lifted when the attached half is removed and re-united with the other on the Permit to Work.

- Material: Polypropylene
- Temperature Range: -10 °C to +90 °C



Please turn to **page 39** for an Isolation Tag how to use guide.



Article No.	Order Reference	Description	Height (mm)	Width (mm)	Packaging
833762	ISO 08	Isolation Tag	200.00	83.00	Pack of 10

The **Brady Visual Tagging Solutions** illustrated in this catalogue are available in a variety of languages. For the product order codes corresponding to the relevant languages, please turn to **pages 40 to 45**.





ADHESIVE STRIPS

Our double-sided adhesive strips are applied to the back of the visual tag holders for attachment to a flat surface.

Article No.	Order Reference	Description	Packaging
833765	ADH PAD	Adhesive Pads	Pack of 10



BLACK CABLE TIES

Our Cable Ties enable secure attachment of Visual Tags to corresponding equipment.

Article No.	Order Reference	Description	Packaging
833767	SUND-CABLE-TIES	Black Cable Ties	Pack of 50



SPLIT RING ATTACHMENT FOR NANOTAG

Split Rings work alongside Nanotag as an attachment option.

Article No.	Order Reference	Description	Packaging
833353	NAN-RING	Split Ring for Nanotag	Pack of 10



STAINLESS STEEL CABLE TIES

Our Stainless Steel Cable Ties offer an alternative to standard Cable Ties and enable secure attachment of Visual Tags to equipment.

Article No.	Order Reference	Description	Packaging
833768	SUND-CABLE-TIES-SS	Stainless Steel Cable Ties	Pack of 40



METAL FIXING RING FOR MAN IN TANK INSERT

Our Metal Fixing Rings are designed to attach 'Man in Tank / Confined Space' Tags to the Entrytag holder.

Article No.	Order Reference	Description	Packaging
831648	ENT-CLIP	Man In Tag Fixing Ring	Pack of 1



WIRE STROPS

Ends of Wire Strop screw together to create a looped secure tie. Used for secure attachment of Visual Tags to equipment.

Article No.	Order Reference	Description	Packaging
833772	SUND-WIRE PH 20	Wire Strop	Pack of 20



REUSABLE CABLE TIES

Reusable cable ties enable secure attachment of Visual Tags to corresponding equipment.

Article No.	Order Reference	Description	Packaging
833769	SUND-REL-100	Reusable Cable Ties	Pack of 100
833770	SUND-REL-140	Reusable Cable Ties	Pack of 140
833771	SUND-REL-250	Reusable Cable Ties	Pack of 250

PEN CLIP HOLDER

The Pen Clip Holder is unobtrusive (13 mm width) and suitable for attachment to Entrytag, Forklifttag, Chemtag and MEWP Tag.

The Pen Clip Holder attaches to the side of the holder to ensure you always have a suitable pen at hand while completing your inspection and maintenance checks.

Pens are not included, they must be ordered separately. The pen clip holders accommodate the Edding 141 F pen supplied as standard with certain products.

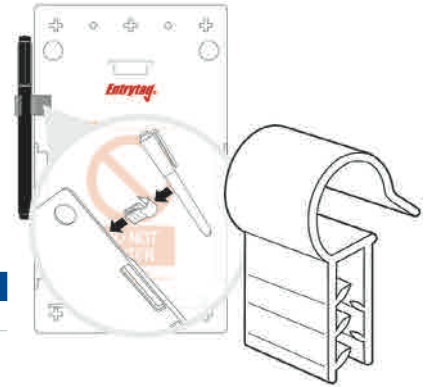

Article No.	Order Reference	Description	Packaging
833759	SUND-PENHOLDER	Pen Clip Holder	Pack of 10

WORKER ID TAG

Worker Emergency ID Tag securely stores the workers critical and potentially lifesaving ID information, essential in the event of a serious accident or medical emergency.

- Adhesive strip attaches securely to exterior of the workers hard hat
- 100% waterproof: can be used in extreme conditions
- Helmet safe: will not weaken or damage the workers hard hat in any way
- Weighs less than 5 grams
- Security flap protects the workers information



Article No.	Order Reference	Description	Packaging
833773	WSID 02	Worker Emergency ID Tag	Pack of 1

PERMIT WALLETS

Permit Document Wallets provide ultimate protection and ease of viewing of permits / documents at the point of use.

- UV and moisture resistant
- Transparent
- Easy access zip closure from top to bottom
- Available in A4 and A5 sizes



Article No.	Order Reference	Description	Packaging
833760	PW1	A4 Permit Wallets	Pack of 1
833761	PW2	A5 Permit Wallets	Pack of 1

PERMANENT MARKING PENS

Permanent Marker Pens to write equipment reference and inspection information on our standard range of visual tags.

Article No.	Order Reference	Description	Packaging
833766	STSM	Permanent Marker Pen	Pack of 10



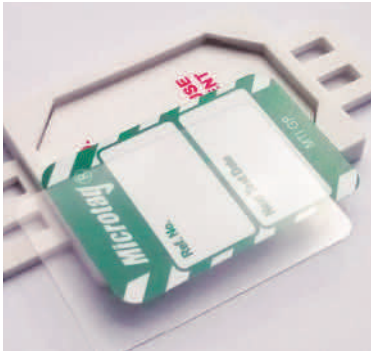

CLEAR COVER INSERTS

Clear covers provide extra protection and increase durability of tag inserts in environments that are prone to dirt.

Article No.	Order Reference	Description	Height (mm)	Width (mm)	Diameter (mm)	Packaging
831640	ENT-ETSI-CL-10	Entrytag Insert	193.00	144.00	-	Pack of 10
832056	MIC-MTI-CL-20	Microtag Insert	47.00	30.00	-	Pack of 20
831914	MUL-EITL-CL-10	Multitag Insert	164.00	50.00	-	Pack of 10
833354	NAN-NAN-CL-20	Nanotag Insert	34.00	18.00	-	Pack of 20
831431	SCAF-STSI-CL-10	Scafftag Insert	208.00	85.00	-	Pack of 10
832732	UNI-UNI-CL-20	Unitag Insert	-	-	41.00	Pack of 20

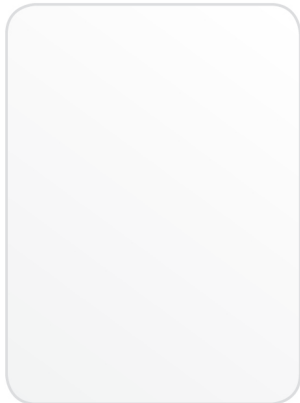

ENTRYTAG® - BLANK INSERTS

Blank Inserts are to be used alongside tag holders for your inspection and maintenance needs to increase communication and safety in your workplace.

Article No.	Order Reference	Description	Colour	Height (mm)	Width (mm)	Packaging
831641	ENT-ETSI-PLAIN-GN-10	Entrytag Insert	Green	193.00	144.00	Pack of 10
831642	ENT-ETSI-PLAIN-RD-10	Entrytag Insert	Red	193.00	144.00	Pack of 10
831643	ENT-ETSI-PLAIN-WH-10	Entrytag Insert	White	193.00	144.00	Pack of 10
831644	ENT-ETSI-PLAIN-YL-10	Entrytag Insert	Yellow	193.00	144.00	Pack of 10
831645	ENT-ETSI-PLAIN-OR-10	Entrytag Insert	Orange	193.00	144.00	Pack of 10
831646	ENT-ETSI-PLAIN-BL-10	Entrytag Insert	Blue	193.00	144.00	Pack of 10
831647	ENT-ETSI-PLAIN-PL-10	Entrytag Insert	Purple	193.00	144.00	Pack of 10



MICROTAG® - BLANK INSERTS

Blank Inserts are to be used alongside tag holders for your inspection and maintenance needs to increase communication and safety in your workplace.

Article No.	Order Reference	Description	Colour	Height (mm)	Width (mm)	Packaging
832050	MIC-MTI-PLAIN-BL-20	Microtag Insert	Blue	47.00	30.00	Pack of 20
832051	MIC-MTI-PLAIN-WH-20	Microtag Insert	White	47.00	30.00	Pack of 20
832052	MIC-MTI-PLAIN-GN-20	Microtag Insert	Green	47.00	30.00	Pack of 20
832053	MIC-MTI-PLAIN-OR-20	Microtag Insert	Orange	47.00	30.00	Pack of 20
832054	MIC-MTI-PLAIN-PL-20	Microtag Insert	Purple	47.00	30.00	Pack of 20
832055	MIC-MTI-PLAIN-RD-20	Microtag Insert	Red	47.00	30.00	Pack of 20
832057	MIC-MTI-PLAIN-YL-20	Microtag Insert	Yellow	47.00	30.00	Pack of 20



MULTITAG® - BLANK INSERTS

Blank Inserts are to be used alongside tag holders for your inspection and maintenance needs to increase communication and safety in your workplace.

Article No.	Order Reference	Description	Colour	Height (mm)	Width (mm)	Packaging
831908	MUL-EITL-PLAIN-YL-10	Multitag Insert	Yellow	164.00	50.00	Pack of 10
831909	MUL-EITL-PLAIN-BL-10	Multitag Insert	Blue	164.00	50.00	Pack of 10
831910	MUL-EITL-PLAIN-RD-10	Multitag Insert	Red	164.00	50.00	Pack of 10
831911	MUL-EITL-PLAIN-GN-10	Multitag Insert	Green	164.00	50.00	Pack of 10
831912	MUL-EITL-PLAIN-WH-10	Multitag Insert	White	164.00	50.00	Pack of 10
831913	MUL-EITL-PLAIN-PL-10	Multitag Insert	Purple	164.00	50.00	Pack of 10

NANOTAG™ - BLANK INSERTS

Blank Inserts are to be used alongside tag holders for your inspection and maintenance needs to increase communication and safety in your workplace.

Article No.	Order Reference	Description	Colour	Height (mm)	Width (mm)	Packaging
833345	NAN-NAN-PLAIN-RD-20	Nanotag Insert	Red	34.00	18.00	Pack of 20
833346	NAN-NAN-PLAIN-WH-20	Nanotag Insert	White	34.00	18.00	Pack of 20
833347	NAN-NAN-PLAIN-BL-20	Nanotag Insert	Blue	34.00	18.00	Pack of 20
833348	NAN-NAN-PLAIN-GN-20	Nanotag Insert	Green	34.00	18.00	Pack of 20
833349	NAN-NAN-PLAIN-YL-20	Nanotag Insert	Yellow	34.00	18.00	Pack of 20
833350	NAN-NAN-PLAIN-OR-20	Nanotag Insert	Orange	34.00	18.00	Pack of 20
833351	NAN-NAN-PLAIN-PL-20	Nanotag Insert	Purple	34.00	18.00	Pack of 20



UNITAG® - BLANK INSERTS

Blank Inserts are to be used alongside tag holders for your inspection and maintenance needs to increase communication and safety in your workplace.

Article No.	Order Reference	Description	Colour	Diameter (mm)	Packaging
832725	UNI-UNI-PLAIN-BL-20	Unitag Insert	Blue	41.00	Pack of 20
832726	UNI-UNI-PLAIN-OR-20	Unitag Insert	Orange	41.00	Pack of 20
832727	UNI-UNI-PLAIN-RD-20	Unitag Insert	Red	41.00	Pack of 20
832728	UNI-UNI-PLAIN-YL-20	Unitag Insert	Yellow	41.00	Pack of 20
832729	UNI-UNI-PLAIN-GN-20	Unitag Insert	Green	41.00	Pack of 20
832730	UNI-UNI-PLAIN-PL-20	Unitag Insert	Purple	41.00	Pack of 20
832731	UNI-UNI-PLAIN-WH-20	Unitag Insert	White	41.00	Pack of 20



SCAFFTAG® MK1 - BLANK INSERTS

Blank Inserts are to be used alongside tag holders for your inspection and maintenance needs to increase communication and safety in your workplace.

Article No.	Order Reference	Description	Colour	Height (mm)	Width (mm)	Packaging
831432	SCAF-STSI-PLAIN-GN-10	Scafftag Insert	Green	208.00	85.00	Pack of 10
831433	SCAF-STSI-PLAIN-YL-10	Scafftag Insert	Yellow	208.00	85.00	Pack of 10
831434	SCAF-STSI-PLAIN-BL-10	Scafftag Insert	Blue	208.00	85.00	Pack of 10
831435	SCAF-STSI-PLAIN-WH-10	Scafftag Insert	White	208.00	85.00	Pack of 10



WHAT IS RFID TECHNOLOGY?

Radio Frequency Identification (RFID) is an automatic identification system which utilises radio waves to transfer a unique ID from a storage medium to a device configured to read it. RFID does not require physical contact between the reader and the storage medium for data transfer to occur, the signal is also able to pass through different object dependent on their physical properties i.e. low frequency radio waves are more effective in environments where there is a lot of metal present.



FORKLIFTAG®

Stage 1



Attach the Forkliftag holder to the cabin of the forklift with cable ties or adhesive in a position which is non-obtrusive to the forklift or operators use but clearly visible. The operator conducts a pre-shift inspection following the pre-use checklist detailed on the Forkliftag insert.

Stage 2



The pre-use check is recorded by the operators signature and date on the Forkliftag insert. If the Forklift is considered fit for use, place the Forkliftag insert into the Forkliftag holder with the daily inspection details displayed, so that anyone can see at a glance when the vehicle was last inspected.

Stage 3



If the forklift is considered not fit for use at any point, remove the Forkliftag insert from the holder and hand over to supervisor. The message 'Do Not Use Until Daily Check Has Been Carried Out or Fork Lift Truck Repaired' with prohibition symbol is clearly visible.

NANOTAG™

Stage 1



Attach the Nanotag holder onto the equipment with a split ring or cable ties in a position where it is clearly visible to the operator but is non-obtrusive to equipment operation, and the prohibition symbol is clearly visible before inspection.

Stage 2



Equipment inspection/testing is conducted by a competent person. If the equipment is considered fit for use, the Nanotag insert is placed in holder with 'Next Test/Inspection Date' recorded.

Stage 3



If the equipment should fail inspection at any point, remove the Nanotag insert from the holder to instantly display the prohibition notice.

UNITAG®

Stage 1



Attach the Unitag holder onto the equipment using the Unitag strip in a position where it is clearly visible to the operator but is non-obtrusive to equipment operation, and the prohibition symbol 'Do Not Use' notice is clearly visible before inspection.

Stage 2

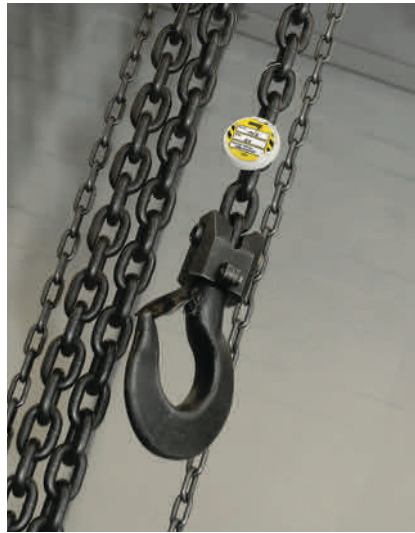

Equipment inspection/testing is conducted by a competent person. If the equipment is considered fit for use, the Unitag insert is placed in holder with 'Next Test/Inspection Date' recorded.

Stage 3

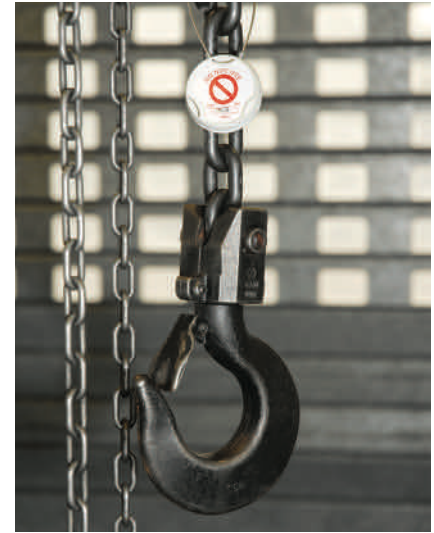

If the equipment should fail testing or inspection at any point, remove the Unitag insert from the holder to instantly display 'Do Not Use' and prohibition notice.

MICROTAG®

Stage 1



Attach the Microtag holder onto the equipment with cable ties or adhesive in a position where it is clearly visible to the operator but is non-obtrusive to equipment operation, and the prohibition symbol and 'Do Not Use Equipment' notice is clearly visible before inspection.

Stage 2

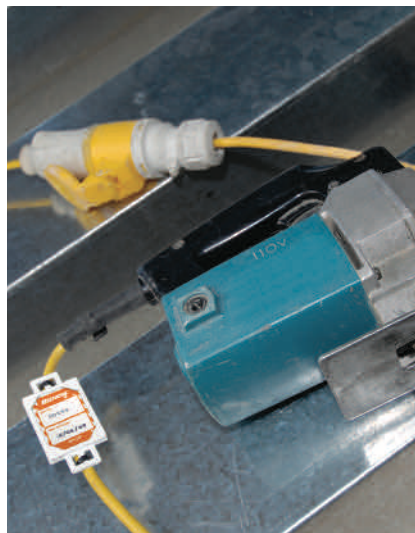

Equipment inspection/testing is conducted by a competent person. If the equipment is considered fit for use, the Microtag insert is placed in holder with 'Next Test/Inspection Date' recorded.

Stage 3

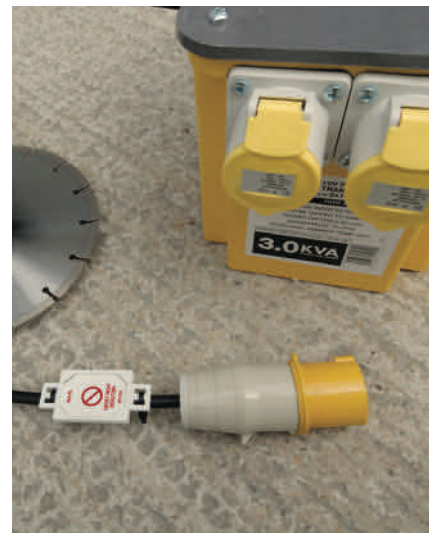

If the equipment should fail testing or inspection at any point, remove the Microtag insert from the holder to instantly display 'Do Not Use Equipment' and prohibition notice.

MEWP TAG

Stage 1



Attach the MEWP Tag holder with cable ties or adhesive near to the operator cabin or access point in a position which is non-obtrusive to the MEWP or operators use but clearly visible. The operator conducts a pre-shift inspection following the pre-use checklist detailed on the MEWP Tag insert.

Stage 2



The pre-use check is recorded by the operators signature and date on the MEWP Tag Insert. If the MEWP is considered fit for use, place the MEWP Tag Insert into the MEWP Tag holder with the daily checklist details displayed, so that anyone can see at a glance when the MEWP was last inspected.

Stage 3



If the MEWP is considered not fit for use at any point, remove the MEWP Tag insert from the holder and hand over to supervisor. The message 'Do Not Use Until Daily Check Has Been Carried Out' with prohibition symbol is clearly visible.

MULTITAG®

Stage 1



Attach the Multitag holder onto the equipment with cable ties or adhesive in a position where it is clearly visible to the operator but is non-obtrusive to the equipment operation, and the prohibition symbol and 'Do Not Use Equipment' notice is clearly visible before inspection.

Stage 2



Equipment inspection is conducted by a competent person. Using the Multitag Insert record the equipment reference number, any additional comments and the next inspection date due. If the equipment is considered fit for use, place the Multitag insert in to the Multitag holder.

Stage 3



If equipment should not be used or fails inspection, remove the Multitag Insert to instantly display the 'Do Not Use This Equipment' and prohibition notice.

SCAFFTAG®

Stage 1



Attach the Scafftag Holder with cable ties or hang on the scaffold pole at all legal access points (normally ladder access) from the first build stage. The empty Scafftag holder will clearly display the prohibition symbol and 'Do Not Use Scaffold' notice.

Stage 2



The scaffold is inspected by a competent person. The scaffold build details are recorded on the Scafftag insert. If the scaffold is considered fit for use, the Scafftag insert is signed and dated and placed in the Scafftag holder.

Stage 3



If the scaffold is considered not fit for use or fails inspection at any point, remove the Scafftag insert from the holder to instantly display 'Do Not Use Scaffold' and prohibition notice.

LADDERTAG®

Stage 1



Attach the Laddertag Holder to the ladder. We advise you attach the Laddertag between the 4th and 5th rung on the inside of the ladder so it is clearly visible but non-obtrusive to the user. Before first use the prohibition symbol and words 'Do Not Use This Ladder' are clearly displayed.

Stage 2



A pre-use checklist is provided on the reverse side of the Laddertag insert. After the ladder is inspected the details are recorded on the Laddertag insert (ladder reference number, ladder class, duty/use, date of next inspection due). Following inspection, if the ladder is considered to be fit for use place the Laddertag insert into the holder.

Stage 3



If the ladder is considered not fit for use at any point, remove the Laddertag insert to instantly display the 'Do Not Use This Ladder' and prohibition notice.

TOWERTAG®

Stage 1



Attach the Towertag holder on the mobile tower with cable ties or using the flexible loop head on the Towertag holder. Attachment position should be close to access point or where it is clearly visible to any user. The empty Towertag holder will clearly display the prohibition symbol and 'Do Not Use Tower' notice.

Stage 2



The mobile tower is inspected by a competent person. The towers build and location details are recorded on the Towertag insert. If the mobile tower is considered fit for use, Towertag insert is signed and dated and placed in the Towertag holder.

Stage 3



If the tower is considered not fit for use or fails inspection at any point, remove the Towertag insert from the holder to instantly display 'Do Not Use Tower' and prohibition notice.

ENTRYTAG®

Stage 1



Attach the Entrytag holder with cable ties, adhesive or magnetic strip to the entrance of the confined space where it is clearly visible. The empty Entrytag holder will display the prohibition symbol and 'Do Not Enter' notice.

Stage 2



A competent person conducts an inspection and records the details on the Entrytag insert. If the area passes inspection place the Entrytag insert into the holder.

Stage 3



If the area should not be entered or fails inspection at any point, remove the Entrytag insert from the holder to instantly display 'Do Not Enter' and prohibition notice.

CHEMTAG®

Stage 1



Attach the Chemtag holder with cable ties or adhesive where it is clearly visible on the storage, racking or room entry. The empty Chemtag holder will clearly display the prohibition symbol and 'Do Not Use' notice.

Stage 2



Complete the Chemtag insert by identifying all chemical hazards and precautions. Write the action to be taken in case of emergency in the space provided. Enter supplier's name, 24 hour emergency telephone number and details of how to store and dispose of packaging. The bottom of the Chemtag insert consists of details of medical warnings associated with the chemical. Place the completed Chemtag insert into the holder.

Stage 3



In the event of an accident the Chemtag insert should be removed from the holder and accompany the patient involved so that the appropriate medical treatment can be administered.

ISOLATION TAG



The Isolation Tag is attached to the asset with cable ties. The tag is perforated so that one section can remain attached to the asset and the other passed to the permitting authority, thereby clearly identifying the current status of the operation to all individuals. By using the perforation on the tag, each section can easily be removed without the need for either scissors or knives which may require additional permits.

PRODUCT INDEX

All the **Brady Visual Tagging Solutions** illustrated in this catalogue are available in a variety of languages as illustrated below.

Using the **Article Number** or **Order Reference** from your required product, select the language of your choice in the corresponding row. This will give you the order code for the product in your language.

If your language of choice is not available, or our standard product does not completely satisfy your requirements turn to **page 4** for more information about customising your Visual Tagging Solution.



Article Number	Order Reference	Description	Danish	Dutch	Finnish	French	German	Norwegian	Russian	Swedish	Turkish
136116	FLT-GB-ETI-51-V2-1-A	Forklifttag Kit	136115	136119	136117	136118	136114	136120	136121	136122	136123
136136	MEWP-GB-ETI-550-V2-1-A	Mobile Elevating Work Platforms Kit	136138	136141	136139	136140	136137	136142	136143	136144	136145
136160	FLT-GB-ETI-51-V2-2-A	Forklifttag Kit	136159	136163	136161	136162	136158	136164	136165	136166	136167
136182	MEWP-GB-ETI-550-V2-2-A	Mobile Elevating Work Platforms Kit	136181	136185	136183	136184	136180	136186	136187	136188	136189
136202	FLT-GB-ETI-51-V2-3-A	Forklifttag Kit	136204	136207	136205	136206	136203	136208	136209	136210	136211
136224	MEWP-GB-ETI-550-V2-3-A	Mobile Elevating Work Platforms Kit	136226	136229	136227	136228	136225	136230	136231	136232	136234
136247	FLT-GB-ETI-51-V2-4-A	Forklifttag Kit	136249	136252	136250	136251	136248	136253	136254	136255	136256
136269	MEWP-GB-ETI-550-V2-4-A	Mobile Elevating Work Platforms Kit	136271	136274	136272	136273	136270	136275	136276	136277	136278
136291	FLT-GB-ETI-51-V2-5-A	Forklifttag Kit	136293	136296	136294	136295	136292	136297	136298	136299	136300
136313	MEWP-GB-ETI-550-V2-5-A	Mobile Elevating Work Platforms Kit	136315	136318	136316	136317	136314	136319	136320	136321	136322
136504	CHEM-GB-CTH-V2-A	Chemtag Holder	136506	136509	136507	136508	136505	136510	136511	136512	136513
136526	CHEM-GB-CTSH-V2-A	Chemtag Kit	136528	136531	136529	136530	136527	136532	136533	136534	136535
136550	ENT-GB-ETSH-V2-A	Entrytag Holder	136549	136553	136551	136552	136548	136554	136555	136556	136557
136572	ENT-GB-ETI-V2-A	Entrytag Kit	136571	136575	136573	136574	136570	136576	136577	136578	136579
136594	FLT-GB-ETSH-V2-A	Forklifttag Holder	136593	136597	136595	136596	136592	136598	136599	136600	136601
137778	MEWP-GB-ETI-550-V2-A	Mobile Elevating Work Platforms Kit	137777	137781	137779	137780	137776	137782	137783	137784	137785
137800	MEWP-GB-ETSH-500-V2-A	Mobile Elevating Work Platforms Holder	137799	137803	137801	137802	137798	137804	137805	137806	137807
137994	ENT-GB-ETSH-V2-MAG-A	Entrytag Holder	137993	137997	137995	137996	137992	137998	137999	138000	138001
138385	FLT-GB-ETI-51-V2-A	Forklifttag Kit	138384	138388	138386	138387	138383	138389	138390	138391	138393
806683	CHEM-GB-CTI-STD-50	Chemtag Insert	831632	806684	831608	806686	806685	831602	831626	831614	831620
806687	CHEM-GB-CTI-STD-10	Chemtag Insert	831631	806688	831607	806689	806690	831601	831625	831613	831619
806695	FLT-GB-ETSI-51-50	Forklifttag Insert	831772	806696	831744	806698	806697	831737	831765	831751	831758
806699	FLT-GB-ETSI-51-10	Forklifttag Insert	831771	806700	831743	806702	806701	831736	831764	831750	831757
806711	LAD-GB-EITH-L12-A	Laddertag Kit	831897	806712	831873	806714	806713	831867	831891	831879	831885
806715	LAD-GB-EITL-12-50	Ladders Insert	831901	806716	831877	806718	806717	831871	831895	831883	831889
806719	LAD-GB-EITL-12-10	Ladders Insert	831900	806720	831876	806722	806721	831870	831894	831882	831888
806723	MIC-MTH-A	Microtag Holder	832645	806724	832353	806726	806725	832280	832572	832426	832499
806731	MIC-MTI-GPI-RD-20	Microtag Insert	832681	832243	832389	832097	832170	832316	832608	832462	832535
806735	MIC-MTI-GPI-YL-20	Microtag Insert	832680	832242	832388	832096	832169	832315	832607	832461	832534
806739	MUL-GB-EITH-L-A	Multitag Kit	831970	806740	831938	806742	806741	831930	831962	831946	831954
806743	MUL-GB-EITL-STD-50	Multitag Insert	831974	806744	831942	806746	806745	831934	831966	831950	831958
806747	MUL-GB-EITL-STD-10	Multitag Insert	831973	806748	831941	806750	806749	831933	831965	831949	831957
806755	SCAF-STSH-A	Scaffitag MK1 Kit	831569	806756	831501	806758	806757	831484	831552	831518	831535
806759	SCAF-STSI-STD-50	Scaffitag MK1 Insert	831574	806760	831506	806762	806761	831489	831557	831523	831540
806787	UNI-UNH-6-SS-A	Unitag Holder	833239	832855	832983	832791	806789	832919	833175	833047	833111
806791	UNI-UNI-GPI-GN-20	Unitag Insert	833276	832892	833020	832828	833893	832956	833212	833084	833148
806795	UNI-UNI-GPI-RD-20	Unitag Insert	833274	832890	833018	832826	833891	832954	833210	833082	833146
806799	UNI-UNI-GPI-YL-20	Unitag Insert	833273	832889	833017	832825	833890	832953	833209	833081	833145
831415	SCAF-STH-A	Scaffitag MK1 Holder	831570	831469	831502	831439	831454	831485	831553	831519	831536
831416	SCAF-STSH-368-SLIT-A	Towertag Kit	831575	831473	831507	831443	831458	831490	831558	831524	831541
831417	SCAF-STH-368-SLIT-A	Towertag Holders	831576	831474	831508	831444	831459	831491	831559	831525	831542
831418	SCAF-STSI-STD-10	Scaffitag MK1 Insert	831572	831471	831504	831441	831456	831487	831555	831521	831538
831419	SCAF-STSI-STD-20	Scaffitag MK1 Insert	831573	831472	831505	831442	831457	831488	831556	831522	831539
831422	SCAF-STSI-368-STD-10	Towertag Insert	831578	831476	831510	831446	831461	831493	831561	831527	831544
831423	SCAF-STSI-368-STD-20	Towertag Insert	831579	831477	831511	831447	831462	831494	831562	831528	831545

PRODUCT INDEX



Article Number	Order Reference	Description	Danish	Dutch	Finnish	French	German	Norwegian	Russian	Swedish	Turkish
831424	SCAF-STSI-368-STD-50	Towertag Insert	831580	831478	831512	831448	831463	831495	831563	831529	831546
831425	SCAF-STSI-PD-10	Special Status Insert	833920	833924	833928	833932	833936	833940	833944	833948	833952
831427	SCAF-STSI-S22-10	Special Status Insert	833922	833926	833930	833934	833938	833942	833946	833950	833954
831429	SCAF-STSI-PRO-10	Prohibition MK1 Insert	831582	831480	831514	831450	831465	831497	831565	831531	831548
831431	SCAF-STSI-CL-10	Scafftag Insert	831431	831431	831431	831431	831431	831431	831431	831431	831431
831432	SCAF-STSI-PLAIN-GN-10	Scafftag Insert	831432	831432	831432	831432	831432	831432	831432	831432	831432
831433	SCAF-STSI-PLAIN-YL-10	Scafftag Insert	831433	831433	831433	831433	831433	831433	831433	831433	831433
831434	SCAF-STSI-PLAIN-BL-10	Scafftag Insert	831434	831434	831434	831434	831434	831434	831434	831434	831434
831435	SCAF-STSI-PLAIN-WH-10	Scafftag Insert	831435	831435	831435	831435	831435	831435	831435	831435	831435
831436	SUND-MISC-189-50	Structural Tie Test Tag	831583	831481	831515	831451	831466	831498	831566	831532	831549
831437	SUND-MISC-190-50	Structural Tie Warning Tags	831584	831482	831516	831452	831467	831499	831567	831533	831550
831637	ENT-ETSI-STD-10	Entrytag Insert	831709	831667	831681	831653	831660	831674	831702	831688	831695
831638	ENT-ETSI-STD-50	Entrytag Insert	831710	831668	831682	831654	831661	831675	831703	831689	831696
831640	ENT-ETSI-CL-10	Entrytag Insert	831640	831640	831640	831640	831640	831640	831640	831640	831640
831641	ENT-ETSI-PLAIN-GN-10	Entrytag Insert	831641	831641	831641	831641	831641	831641	831641	831641	831641
831642	ENT-ETSI-PLAIN-RD-10	Entrytag Insert	831642	831642	831642	831642	831642	831642	831642	831642	831642
831643	ENT-ETSI-PLAIN-WH-10	Entrytag Insert	831643	831643	831643	831643	831643	831643	831643	831643	831643
831644	ENT-ETSI-PLAIN-YL-10	Entrytag Insert	831644	831644	831644	831644	831644	831644	831644	831644	831644
831645	ENT-ETSI-PLAIN-OR-10	Entrytag Insert	831645	831645	831645	831645	831645	831645	831645	831645	831645
831646	ENT-ETSI-PLAIN-BL-10	Entrytag Insert	831646	831646	831646	831646	831646	831646	831646	831646	831646
831647	ENT-ETSI-PLAIN-PL-10	Entrytag Insert	831647	831647	831647	831647	831647	831647	831647	831647	831647
831648	ENT-CLIP	Man In Tag Fixing Ring	831648	831648	831648	831648	831648	831648	831648	831648	831648
831778	MEWP-GB-ETSI-550-10	Mobile Elevating Work Platforms Insert	831845	831803	831817	831789	831796	831810	831838	831824	831831
831779	MEWP-GB-ETSI-550-50	Mobile Elevating Work Platforms Insert	831846	831804	831818	831790	831797	831811	831839	831825	831832
831850	LAD-GB-EITH-12-A	Ladders Holder	831898	811003	831874	811005	811004	831868	831892	831880	831886
831859	LAD-ADHESIVEPAD	Ladders Piece	831859	831859	831859	831859	831859	831859	831859	831859	831859
831904	MUL-GB-EITH-A	Multitag Holder	831971	811019	831939	811021	811020	831931	831963	831947	831955
831908	MUL-EITL-PLAIN-YL-10	Multitag Insert	831908	831908	831908	831908	831908	831908	831908	831908	831908
831909	MUL-EITL-PLAIN-BL-10	Multitag Insert	831909	831909	831909	831909	831909	831909	831909	831909	831909
831910	MUL-EITL-PLAIN-RD-10	Multitag Insert	831910	831910	831910	831910	831910	831910	831910	831910	831910
831911	MUL-EITL-PLAIN-GN-10	Multitag Insert	831911	831911	831911	831911	831911	831911	831911	831911	831911
831912	MUL-EITL-PLAIN-WH-10	Multitag Insert	831912	831912	831912	831912	831912	831912	831912	831912	831912
831913	MUL-EITL-PLAIN-PL-10	Multitag Insert	831913	831913	831913	831913	831913	831913	831913	831913	831913
831914	MUL-EITL-CL-10	Multitag Insert	831914	831914	831914	831914	831914	831914	831914	831914	831914
831915	MUL-EITL-577	Man In Confined Space Tag	831975	831927	831943	831919	831923	831935	831967	831951	831959
831916	MUL-EITL-529	Man In Tank Tag	831976	831928	831944	831920	831924	831936	831968	831952	831960
831979	MIC-MTH-BARCODE-A	Microtag Barcode Holder	832646	832208	832354	832062	832135	832281	832573	832427	832500
831980	MIC-MTI-GP-RD-20	Microtag Insert	832647	832209	832355	832063	832136	832282	832574	832428	832501
831981	MIC-MTI-GP-BL-20	Microtag Insert	832648	832210	832356	832064	832137	832283	832575	832429	832502
831982	MIC-MTI-GP-GN-20	Microtag Insert	832649	832211	832357	832065	832138	832284	832576	832430	832503
831983	MIC-MTI-GP-OR-20	Microtag Insert	832650	832212	832358	832066	832139	832285	832577	832431	832504
831984	MIC-MTI-GP-PL-20	Microtag Insert	832651	832213	832359	832067	832140	832286	832578	832432	832505
831985	MIC-MTI-GP-WH-20	Microtag Insert	832652	832214	832360	832068	832141	832287	832579	832433	832506
831986	MIC-MTI-GP-YL-20	Microtag Insert	832653	832215	832361	832069	832142	832288	832580	832434	832507
831987	MIC-PK-GP-GN	Microtag Kit	832654	832216	832362	832070	832143	832289	832581	832435	832508
831988	MIC-PK-GP-BL	Microtag Kit	832655	832217	832363	832071	832144	832290	832582	832436	832509
831989	MIC-PK-GP-RD	Microtag Kit	832656	832218	832364	832072	832145	832291	832583	832437	832510
831990	MIC-PK-GP-OR	Microtag Kit	832657	832219	832365	832073	832146	832292	832584	832438	832511

PRODUCT INDEX



Article Number	Order Reference	Description	Danish	Dutch	Finnish	French	German	Norwegian	Russian	Swedish	Turkish
831991	MIC-PK-GP-YL	Microtag Kit	832658	832220	832366	832074	832147	832293	832585	832439	832512
831992	MIC-PK-GP-PL	Microtag Kit	832659	832221	832367	832075	832148	832294	832586	832440	832513
831993	MIC-PK-GP-WH	Microtag Kit	832660	832222	832368	832076	832149	832295	832587	832441	832514
831994	MIC-MTI-I-BL-20	Microtag Insert	832661	832223	832369	832077	832150	832296	832588	832442	832515
831995	MIC-MTI-I-GN-20	Microtag Insert	832662	832224	832370	832078	832151	832297	832589	832443	832516
831996	MIC-MTI-I-OR-20	Microtag Insert	832663	832225	832371	832079	832152	832298	832590	832444	832517
831997	MIC-MTI-I-PL-20	Microtag Insert	832664	832226	832372	832080	832153	832299	832591	832445	832518
831998	MIC-MTI-I-RD-20	Microtag Insert	832665	832227	832373	832081	832154	832300	832592	832446	832519
831999	MIC-MTI-I-YL-20	Microtag Insert	832666	832228	832374	832082	832155	832301	832593	832447	832520
832000	MIC-MTI-I-WH-20	Microtag Insert	832667	832229	832375	832083	832156	832302	832594	832448	832521
832001	MIC-PK-MTI-I-BL	Microtag Kit	832668	832230	832376	832084	832157	832303	832595	832449	832522
832002	MIC-PK-MTI-I-YL	Microtag Kit	832669	832231	832377	832085	832158	832304	832596	832450	832523
832003	MIC-PK-MTI-I-RD	Microtag Kit	832670	832232	832378	832086	832159	832305	832597	832451	832524
832004	MIC-PK-MTI-I-GN	Microtag Kit	832671	832233	832379	832087	832160	832306	832598	832452	832525
832005	MIC-PK-MTI-I-WH	Microtag Kit	832672	832234	832380	832088	832161	832307	832599	832453	832526
832006	MIC-PK-MTI-I-OR	Microtag Kit	832673	832235	832381	832089	832162	832308	832600	832454	832527
832007	MIC-PK-MTI-I-PL	Microtag Kit	832674	832236	832382	832090	832163	832309	832601	832455	832528
832008	MIC-MTI-GPI-BL-20	Microtag Insert	832675	832237	832383	832091	832164	832310	832602	832456	832529
832009	MIC-MTI-GPI-GN-20	Microtag Insert	832676	832238	832384	832092	832165	832311	832603	832457	832530
832010	MIC-MTI-GPI-OR-20	Microtag Insert	832677	832239	832385	832093	832166	832312	832604	832458	832531
832011	MIC-MTI-GPI-PL-20	Microtag Insert	832678	832240	832386	832094	832167	832313	832605	832459	832532
832012	MIC-MTI-GPI-WH-20	Microtag Insert	832679	832241	832387	832095	832168	832314	832606	832460	832533
832015	MIC-PK-GPI-YL	Microtag Kit	832682	832244	832390	832098	832171	832317	832609	832463	832536
832016	MIC-PK-GPI-PL	Microtag Kit	832683	832245	832391	832099	832172	832318	832610	832464	832537
832017	MIC-PK-GPI-WH	Microtag Kit	832684	832246	832392	832100	832173	832319	832611	832465	832538
832018	MIC-PK-GPI-RD	Microtag Kit	832685	832247	832393	832101	832174	832320	832612	832466	832539
832019	MIC-PK-GPI-OR	Microtag Kit	832686	832248	832394	832102	832175	832321	832613	832467	832540
832020	MIC-PK-GPI-GN	Microtag Kit	832687	832249	832395	832103	832176	832322	832614	832468	832541
832021	MIC-PK-GPI-BL	Microtag Kit	832688	832250	832396	832104	832177	832323	832615	832469	832542
832022	MIC-MTI-405-PL-20	Microtag Insert	832689	832251	832397	832105	832178	832324	832616	832470	832543
832023	MIC-MTI-405-OR-20	Microtag Insert	832690	832252	832398	832106	832179	832325	832617	832471	832544
832024	MIC-MTI-405-YL-20	Microtag Insert	832691	832253	832399	832107	832180	832326	832618	832472	832545
832025	MIC-MTI-405-BL-20	Microtag Insert	832692	832254	832400	832108	832181	832327	832619	832473	832546
832026	MIC-MTI-405-RD-20	Microtag Insert	832693	832255	832401	832109	832182	832328	832620	832474	832547
832027	MIC-MTI-405-GN-20	Microtag Insert	832694	832256	832402	832110	832183	832329	832621	832475	832548
832028	MIC-MTI-405-WH-20	Microtag Insert	832695	832257	832403	832111	832184	832330	832622	832476	832549
832029	MIC-PK-MTI-405-BL	Microtag Kit	832696	832258	832404	832112	832185	832331	832623	832477	832550
832030	MIC-PK-MTI-405-GN	Microtag Kit	832697	832259	832405	832113	832186	832332	832624	832478	832551
832031	MIC-PK-MTI-405-OR	Microtag Kit	832698	832260	832406	832114	832187	832333	832625	832479	832552
832032	MIC-PK-MTI-405-RD	Microtag Kit	832699	832261	832407	832115	832188	832334	832626	832480	832553
832033	MIC-PK-MTI-405-YL	Microtag Kit	832700	832262	832408	832116	832189	832335	832627	832481	832554
832034	MIC-PK-MTI-405-WH	Microtag Kit	832701	832263	832409	832117	832190	832336	832628	832482	832555
832035	MIC-PK-MTI-405-PL	Microtag Kit	832702	832264	832410	832118	832191	832337	832629	832483	832556
832036	MIC-MTI-451-PL-20	Microtag Insert	832703	832265	832411	832119	832192	832338	832630	832484	832557
832037	MIC-MTI-451-GN-20	Microtag Insert	832704	832266	832412	832120	832193	832339	832631	832485	832558
832038	MIC-MTI-451-BL-20	Microtag Insert	832705	832267	832413	832121	832194	832340	832632	832486	832559
832039	MIC-MTI-451-YL-20	Microtag Insert	832706	832268	832414	832122	832195	832341	832633	832487	832560
832040	MIC-MTI-451-RD-20	Microtag Insert	832707	832269	832415	832123	832196	832342	832634	832488	832561
832041	MIC-MTI-451-OR-20	Microtag Insert	832708	832270	832416	832124	832197	832343	832635	832489	832562
832042	MIC-MTI-451-WH-20	Microtag Insert	832709	832271	832417	832125	832198	832344	832636	832490	832563
832043	MIC-PK-MTI-451-OR	Microtag Kit	832710	832272	832418	832126	832199	832345	832637	832491	832564
832044	MIC-PK-MTI-451-GN	Microtag Kit	832711	832273	832419	832127	832200	832346	832638	832492	832565
832045	MIC-PK-MTI-451-RD	Microtag Kit	832712	832274	832420	832128	832201	832347	832639	832493	832566
832046	MIC-PK-MTI-451-YL	Microtag Kit	832713	832275	832421	832129	832202	832348	832640	832494	832567
832047	MIC-PK-MTI-451-BL	Microtag Kit	832714	832276	832422	832130	832203	832349	832641	832495	832568
832048	MIC-PK-MTI-451-PL	Microtag Kit	832715	832277	832423	832131	832204	832350	832642	832496	832569
832049	MIC-PK-MTI-451-WH	Microtag Kit	832716	832278	832424	832132	832205	832351	832643	832497	832570
832050	MIC-MTI-PLAIN-BL-20	Microtag Insert	832050	832050	832050	832050	832050	832050	832050	832050	832050

PRODUCT INDEX



Article Number	Order Reference	Description	Danish	Dutch	Finnish	French	German	Norwegian	Russian	Swedish	Turkish
832051	MIC-MTI-PLAIN-WH-20	Microtag Insert	832051	832051	832051	832051	832051	832051	832051	832051	832051
832052	MIC-MTI-PLAIN-GN-20	Microtag Insert	832052	832052	832052	832052	832052	832052	832052	832052	832052
832053	MIC-MTI-PLAIN-OR-20	Microtag Insert	832053	832053	832053	832053	832053	832053	832053	832053	832053
832054	MIC-MTI-PLAIN-PL-20	Microtag Insert	832054	832054	832054	832054	832054	832054	832054	832054	832054
832055	MIC-MTI-PLAIN-RD-20	Microtag Insert	832055	832055	832055	832055	832055	832055	832055	832055	832055
832056	MIC-MTI-CL-20	Microtag Insert	832056	832056	832056	832056	832056	832056	832056	832056	832056
832057	MIC-MTI-PLAIN-YL-20	Microtag Insert	832057	832057	832057	832057	832057	832057	832057	832057	832057
832718	UNI-UNH-6-A	Unitag Holder	833238	832854	832982	832790	833856	832918	833174	833046	833110
832720	UNI-UNH-6-PC-A	Unitag Holder	833240	832856	832984	832792	833857	832920	833176	833048	833112
832721	UNI-UNH-9-A	Unitag Holder	833241	832857	832985	832793	833858	832921	833177	833049	833113
832722	UNI-UNH-9-SS-A	Unitag Holder	833242	832858	832986	832794	833859	832922	833178	833050	833114
832723	UNI-UNH-9-PC-A	Unitag Holder	833243	832859	832987	832795	833860	832923	833179	833051	833115
832724	UNI-UNH-12-A	Unitag Holder	833244	832860	832988	832796	833861	832924	833180	833052	833116
832725	UNI-UNI-PLAIN-BL-20	Unitag Insert	832725	832725	832725	832725	832725	832725	832725	832725	832725
832726	UNI-UNI-PLAIN-OR-20	Unitag Insert	832726	832726	832726	832726	832726	832726	832726	832726	832726
832727	UNI-UNI-PLAIN-RD-20	Unitag Insert	832727	832727	832727	832727	832727	832727	832727	832727	832727
832728	UNI-UNI-PLAIN-YL-20	Unitag Insert	832728	832728	832728	832728	832728	832728	832728	832728	832728
832729	UNI-UNI-PLAIN-GN-20	Unitag Insert	832729	832729	832729	832729	832729	832729	832729	832729	832729
832730	UNI-UNI-PLAIN-PL-20	Unitag Insert	832730	832730	832730	832730	832730	832730	832730	832730	832730
832731	UNI-UNI-PLAIN-WH-20	Unitag Insert	832731	832731	832731	832731	832731	832731	832731	832731	832731
832732	UNI-UNI-CL-20	Unitag Insert	832732	832732	832732	832732	832732	832732	832732	832732	832732
832733	UNI-UNI-I-WH-20	Unitag Insert	833245	832861	832989	832797	833862	832925	833181	833053	833117
832734	UNI-UNI-I-PL-20	Unitag Insert	833246	832862	832990	832798	833863	832926	833182	833054	833118
832735	UNI-UNI-I-OR-20	Unitag Insert	833247	832863	832991	832799	833864	832927	833183	833055	833119
832736	UNI-UNI-I-GN-20	Unitag Insert	833248	832864	832992	832800	833865	832928	833184	833056	833120
832737	UNI-UNI-I-BL-20	Unitag Insert	833249	832865	832993	832801	833866	832929	833185	833057	833121
832738	UNI-UNI-I-RD-20	Unitag Insert	833250	832866	832994	832802	833867	832930	833186	833058	833122
832739	UNI-UNI-I-YL-20	Unitag Insert	833251	832867	832995	832803	833868	832931	833187	833059	833123
832740	UNI-PK-UNI-I-RD	Unitag Kit	833252	832868	832996	832804	833869	832932	833188	833060	833124
832741	UNI-PK-UNI-I-YL	Unitag Kit	833253	832869	832997	832805	833870	832933	833189	833061	833125
832742	UNI-PK-UNI-I-BL	Unitag Kit	833254	832870	832998	832806	833871	832934	833190	833062	833126
832743	UNI-PK-UNI-I-WH	Unitag Kit	833255	832871	832999	832807	833872	832935	833191	833063	833127
832744	UNI-PK-UNI-I-PL	Unitag Kit	833256	832872	833000	832808	833873	832936	833192	833064	833128
832745	UNI-PK-UNI-I-OR	Unitag Kit	833257	832873	833001	832809	833874	832937	833193	833065	833129
832746	UNI-PK-UNI-I-GN	Unitag Kit	833258	832874	833002	832810	833875	832938	833194	833066	833130
832747	UNI-UNI-GP-RD-20	Unitag Insert	833259	832875	833003	832811	833876	832939	833195	833067	833131
832748	UNI-UNI-GP-BL-20	Unitag Insert	833260	832876	833004	832812	833877	832940	833196	833068	833132
832749	UNI-UNI-GP-GN-20	Unitag Insert	833261	832877	833005	832813	833878	832941	833197	833069	833133
832750	UNI-UNI-GP-OR-20	Unitag Insert	833262	832878	833006	832814	833879	832942	833198	833070	833134
832751	UNI-UNI-GP-PL-20	Unitag Insert	833263	832879	833007	832815	833880	832943	833199	833071	833135
832752	UNI-UNI-GP-WH-20	Unitag Insert	833264	832880	833008	832816	833881	832944	833200	833072	833136
832753	UNI-UNI-GP-YL-20	Unitag Insert	833265	832881	833009	832817	833882	832945	833201	833073	833137
832754	UNI-PK-GP-YL	Unitag Kit	833266	832882	833010	832818	833883	832946	833202	833074	833138
832755	UNI-PK-GP-GN	Unitag Kit	833267	832883	833011	832819	833884	832947	833203	833075	833139
832756	UNI-PK-GP-RD	Unitag Kit	833268	832884	833012	832820	833885	832948	833204	833076	833140
832757	UNI-PK-GP-WH	Unitag Kit	833269	832885	833013	832821	833886	832949	833205	833077	833141
832758	UNI-PK-GP-BL	Unitag Kit	833270	832886	833014	832822	833887	832950	833206	833078	833142
832759	UNI-PK-GP-PL	Unitag Kit	833271	832887	833015	832823	833888	832951	833207	833079	833143
832760	UNI-PK-GP-OR	Unitag Kit	833272	832888	833016	832824	833889	832952	833208	833080	833144
832763	UNI-UNI-GPI-BL-20	Unitag Insert	833275	832891	833019	832827	833892	832955	833211	833083	833147
832765	UNI-UNI-GPI-OR-20	Unitag Insert	833277	832893	833021	832829	833894	832957	833213	833085	833149
832766	UNI-UNI-GPI-PL-20	Unitag Insert	833278	832894	833022	832830	833895	832958	833214	833086	833150
832767	UNI-UNI-GPI-WH-20	Unitag Insert	833279	832895	833023	832831	833896	832959	833215	833087	833151
832768	UNI-UNI-GPI-BL	Unitag Insert	833280	832896	833024	832832	833897	832960	833216	833088	833152
832769	UNI-PK-GPI-RD	Unitag Kit	833281	832897	833025	832833	833898	832961	833217	833089	833153
832770	UNI-PK-GPI-GN	Unitag Kit	833282	832898	833026	832834	833899	832962	833218	833090	833154
832771	UNI-PK-GPI-YL	Unitag Kit	833283	832899	833027	832835	833900	832963	833219	833091	833155
832772	UNI-PK-GPI-OR	Unitag Kit	833284	832900	833028	832836	833901	832964	833220	833092	833156

PRODUCT INDEX



Article Number	Order Reference	Description	Danish	Dutch	Finnish	French	German	Norwegian	Russian	Swedish	Turkish
832773	UNI-PK-GPI-PL	Unitag Kit	833285	832901	833029	832837	833902	832965	833221	833093	833157
832774	UNI-PK-GPI-WH	Unitag Kit	833286	832902	833030	832838	833903	832966	833222	833094	833158
833302	NAN-NAN-A	Nanotag Holder	833708	833444	833532	833356	833400	833488	833664	833576	833620
833303	NAN-NAN-GP-OR-20	Nanotag Insert	833709	833445	833533	833357	833401	833489	833665	833577	833621
833304	NAN-NAN-GP-YL-20	Nanotag Insert	833710	833446	833534	833358	833402	833490	833666	833578	833622
833305	NAN-NAN-GP-BL-20	Nanotag Insert	833711	833447	833535	833359	833403	833491	833667	833579	833623
833306	NAN-NAN-GP-GN-20	Nanotag Insert	833712	833448	833536	833360	833404	833492	833668	833580	833624
833307	NAN-NAN-GP-RD-20	Nanotag Insert	833713	833449	833537	833361	833405	833493	833669	833581	833625
833308	NAN-NAN-GP-WH-20	Nanotag Insert	833714	833450	833538	833362	833406	833494	833670	833582	833626
833309	NAN-NAN-GP-PL-20	Nanotag Insert	833715	833451	833539	833363	833407	833495	833671	833583	833627
833310	NAN-PK-GP-BL	Nanotag Kit	833716	833452	833540	833364	833408	833496	833672	833584	833628
833311	NAN-PK-GP-PL	Nanotag Kit	833717	833453	833541	833365	833409	833497	833673	833585	833629
833312	NAN-PK-GP-YL	Nanotag Kit	833718	833454	833542	833366	833410	833498	833674	833586	833630
833313	NAN-PK-GP-GN	Nanotag Kit	833719	833455	833543	833367	833411	833499	833675	833587	833631
833314	NAN-PK-GP-OR	Nanotag Kit	833720	833456	833544	833368	833412	833500	833676	833588	833632
833315	NAN-PK-GP-RD	Nanotag Kit	833721	833457	833545	833369	833413	833501	833677	833589	833633
833316	NAN-PK-GP-WH	Nanotag Kit	833722	833458	833546	833370	833414	833502	833678	833590	833634
833317	NAN-NAN-GPI-YL-20	Nanotag Insert	833723	833459	833547	833371	833415	833503	833679	833591	833635
833318	NAN-NAN-GPI-OR-20	Nanotag Insert	833724	833460	833548	833372	833416	833504	833680	833592	833636
833319	NAN-NAN-GPI-RD-20	Nanotag Insert	833725	833461	833549	833373	833417	833505	833681	833593	833637
833320	NAN-NAN-GPI-BL-20	Nanotag Insert	833726	833462	833550	833374	833418	833506	833682	833594	833638
833321	NAN-NAN-GPI-GN-20	Nanotag Insert	833727	833463	833551	833375	833419	833507	833683	833595	833639
833322	NAN-NAN-GPI-PL-20	Nanotag Insert	833728	833464	833552	833376	833420	833508	833684	833596	833640
833323	NAN-NAN-GPI-WH-20	Nanotag Insert	833729	833465	833553	833377	833421	833509	833685	833597	833641
833324	NAN-PK-GPI-PL	Nanotag Kit	833730	833466	833554	833378	833422	833510	833686	833598	833642
833325	NAN-PK-GPI-BL	Nanotag Kit	833731	833467	833555	833379	833423	833511	833687	833599	833643
833326	NAN-PK-GPI-GN	Nanotag Kit	833732	833468	833556	833380	833424	833512	833688	833600	833644
833327	NAN-PK-GPI-RD	Nanotag Kit	833733	833469	833557	833381	833425	833513	833689	833601	833645
833328	NAN-PK-GPI-OR	Nanotag Kit	833734	833470	833558	833382	833426	833514	833690	833602	833646
833329	NAN-PK-GPI-WH	Nanotag Kit	833735	833471	833559	833383	833427	833515	833691	833603	833647
833330	NAN-PK-GPI-YL	Nanotag Kit	833736	833472	833560	833384	833428	833516	833692	833604	833648
833331	NAN-NAN-I-RD-20	Nanotag Insert	833737	833473	833561	833385	833429	833517	833693	833605	833649
833332	NAN-NAN-I-BL-20	Nanotag Insert	833738	833474	833562	833386	833430	833518	833694	833606	833650
833333	NAN-NAN-I-YL-20	Nanotag Insert	833739	833475	833563	833387	833431	833519	833695	833607	833651
833334	NAN-NAN-I-GN-20	Nanotag Insert	833740	833476	833564	833388	833432	833520	833696	833608	833652
833335	NAN-NAN-I-WH-20	Nanotag Insert	833741	833477	833565	833389	833433	833521	833697	833609	833653
833336	NAN-NAN-I-PL-20	Nanotag Insert	833742	833478	833566	833390	833434	833522	833698	833610	833654
833337	NAN-NAN-I-OR-20	Nanotag Insert	833743	833479	833567	833391	833435	833523	833699	833611	833655
833338	NAN-PK-NAN-I-YL	Nanotag Kit	833744	833480	833568	833392	833436	833524	833700	833612	833656
833339	NAN-PK-NAN-I-RD	Nanotag Kit	833745	833481	833569	833393	833437	833525	833701	833613	833657
833340	NAN-PK-NAN-I-GN	Nanotag Kit	833746	833482	833570	833394	833438	833526	833702	833614	833658

PRODUCT INDEX



Article Number	Order Reference	Description	Danish	Dutch	Finnish	French	German	Norwegian	Russian	Swedish	Turkish
833341	NAN-PK-NAN-I-BL	Nanotag Kit	833747	833483	833571	833395	833439	833527	833703	833615	833659
833342	NAN-PK-NAN-I-PL	Nanotag Kit	833748	833484	833572	833396	833440	833528	833704	833616	833660
833343	NAN-PK-NAN-I-OR	Nanotag Kit	833749	833485	833573	833397	833441	833529	833705	833617	833661
833344	NAN-PK-NAN-I-WH	Nanotag Kit	833750	833486	833574	833398	833442	833530	833706	833618	833662
833345	NAN-NAN-PLAIN-RD-20	Nanotag Insert	833345	833345	833345	833345	833345	833345	833345	833345	833345
833346	NAN-NAN-PLAIN-WH-20	Nanotag Insert	833346	833346	833346	833346	833346	833346	833346	833346	833346
833347	NAN-NAN-PLAIN-BL-20	Nanotag Insert	833347	833347	833347	833347	833347	833347	833347	833347	833347
833348	NAN-NAN-PLAIN-GN-20	Nanotag Insert	833348	833348	833348	833348	833348	833348	833348	833348	833348
833349	NAN-NAN-PLAIN-YL-20	Nanotag Insert	833349	833349	833349	833349	833349	833349	833349	833349	833349
833350	NAN-NAN-PLAIN-OR-20	Nanotag Insert	833350	833350	833350	833350	833350	833350	833350	833350	833350
833351	NAN-NAN-PLAIN-PL-20	Nanotag Insert	833351	833351	833351	833351	833351	833351	833351	833351	833351
833353	NAN-RING	Split Ring for Nanotag	833353	833353	833353	833353	833353	833353	833353	833353	833353
833354	NAN-NAN-CL-20	Nanotag Insert	833354	833354	833354	833354	833354	833354	833354	833354	833354
833754	STH 2	Scafftag MK2 Holder	833784	833785	833786	833787	833788	833789	833790	833791	833792
833755	STSH MK2	Scafftag MK2 Kit	833793	833794	833795	833796	833797	833798	833799	833800	833801
833756	STSI 369 ETS	Scafftag MK2 Insert	833802	833803	833804	833805	833806	833807	833808	833809	833810
833757	STSIP ETS	Prohibition MK2 Insert	833811	833812	833813	833814	833815	833816	833817	833818	833819
833758	FLT-DCB	Forklifttag Booklet	833820	833821	833822	833823	833824	833825	833826	833827	833828
833759	SUND-PENHOLDER	Pen Clip Holder	833759	833759	833759	833759	833759	833759	833759	833759	833759
833760	PW1	A4 Permit Wallets	833760	833760	833760	833760	833760	833760	833760	833760	833760
833761	PW2	A5 Permit Wallets	833761	833761	833761	833761	833761	833761	833761	833761	833761
833762	ISO 08	Isolation Tag	833829	833830	833831	833832	833833	833834	833835	833836	833837
833763	STSI 422DS	3 Part Joint Tag	833838	833839	833840	833841	833842	833843	833844	833845	833846
833764	STSI 522A	3 Part Flange Tag	833847	833848	833849	833850	833851	833852	833853	833854	833855
833765	ADH PAD	Adhesive Pads	833765	833765	833765	833765	833765	833765	833765	833765	833765
833766	STSM	Permanent Marker Pen	833766	833766	833766	833766	833766	833766	833766	833766	833766
833767	SUND-CABLE-TIES	Black Cable Ties	833767	833767	833767	833767	833767	833767	833767	833767	833767
833768	SUND-CABLE-TIES-SS	Stainless Steel Cable Ties	833768	833768	833768	833768	833768	833768	833768	833768	833768
833769	SUND-REL-100	Reusable Cable Ties	833769	833769	833769	833769	833769	833769	833769	833769	833769
833770	SUND-REL-140	Reusable Cable Ties	833770	833770	833770	833770	833770	833770	833770	833770	833770
833771	SUND-REL-250	Reusable Cable Ties	833771	833771	833771	833771	833771	833771	833771	833771	833771
833772	SUND-WIRE PH 20	Wire Strop	833772	833772	833772	833772	833772	833772	833772	833772	833772
833773	WSID 02	Worker Emergency ID Tag	833773	833773	833773	833773	833773	833773	833773	833773	833773

More literature from Brady

BRADY
WHEN PERFORMANCE MATTERS MOST™



Pipe Marking
Have a clear understanding of what is running through your pipes



Area Marking

BRADY
WHEN PERFORMANCE MATTERS MOST™



Lockout / Tagout



Solutions for Hazardous Energy Control
Create, visualise and manage your Isolation Programme

BRADY
WHEN PERFORMANCE MATTERS MOST™



Area Marking



**Please contact
your local
customer services
to request
our literature.**

Please contact your local customer services to request our literature.

BRADY - YOUR COMPLETE WORK SAFETY SOLUTION PROVIDER

Find out more safety products from our extensive portfolio. Visit www.bradyeurope.com or contact your nearest Brady Distributor.

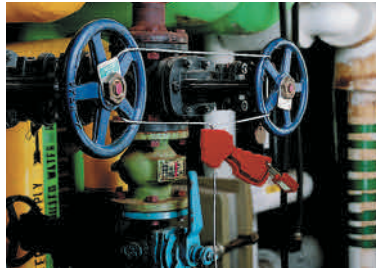

LOCKOUT/TAGOUT -

SOLUTIONS FOR HAZARDOUS ENERGY CONTROL

From audit and identification of energy control points, through procedure creation and the selection of adequate products, up to employee training and safety awareness promotion – Brady offers full support and a broad range of products to create your advanced work safety environment.



SAFETY SIGNS -

IMPORTANT INFORMATION AT THE POINT OF NEED

We offer more than 8,000 different signs for safety, maintenance and facility identification.

- Designed to withstand even the harshest industrial environments
- Bright colours, bold text and intuitive pictograms
- Compliant with the latest standards and regulations
- Highly visible and easy to understand communication



PIPE MARKERS -

EASILY IDENTIFY PIPE CONTENT AND FLOW DIRECTION

The correct identification of pipes ensures a better insight into a building's structure. Accidents, injuries and damage can be prevented.



SORBENTS -

SMART SPILL CONTROL

Clean, fast and safe removal of oil, water and chemicals spills.

- Adsorbs 10-25 times its own weight within a few seconds
- Environmentally friendly
- Spend less time cleaning



AREA AND LOGISTICS MARKING

Creating a totally safe work environment requires several elements, clear signage and area marking is essential but is not sufficient by itself. Brady offers a complete range of additional marking methods with a variety of applications including:

- Floor marking
- Barricade and underground tapes
- Logistics and warehouse labelling
- Photoluminescent marking
- Stands and posts
- Safety Bumpers



DO-IT-YOURSELF SIGN MAKING

Brady offers a full range of printer solutions to make your own Safety Signs. Choose from a variety of capabilities and options to provide high quality, cost-effective printing on a complete line of labelling materials.

Brady Corporation

Our mission is To Identify and Protect Premises, Products and People



Company Overview

BRADY was founded in 1914 in Eau Claire, Wisconsin, as W.H. BRADY Co., and renamed BRADY Corporation in 1998. The company began selling products internationally in 1947. In 1984, BRADY went public, with stock trading on the Nasdaq Stock Market, and in 1999, moved trading of its stock to the New York Stock Exchange, where it trades under the symbol BRC. The company's global headquarters is in Milwaukee, Wisconsin.

Brady manufactures and markets:

- products for identification and safety applications such as signs and markers, and printing systems and software to produce identification products on site and on demand.
- products for wire identification, including labelling materials and tools for wire and cable marking in the electrical and telecommunication markets
- high-performance identification products, including labels and signs that remain legible and highly adhesive even in harsh environments
- identify people and enhance security by ensuring the right persons are in the right places at the right time

Operations – Some facts:

- 6500 employees around the world
- Operations in 29 countries
- Distribution in more than 100 countries through more than 4,400 distributor partners

BRADY WHEN PERFORMANCE MATTERS MOST™

BRADY Africa

361 Olympic Duel,
Northlands Business Park
Newmarket Road
Randburg
Tel: +27 11 704 3295
Fax: +27 86 501 7775

BRADY Benelux

Industriepark C/3
Lindestraat 20
9240 Zele, Belgium
Tel. +32 (0)52 45 78 11
Fax +32 (0)52 45 78 12

BRADY Central & Eastern Europe

Na Pántoch 18
831 06 Bratislava, Slovakia
Tel. +421 2 3300 4800
Fax +421 2 3300 4801

BRADY Denmark

Svendborgvej 39D
5260 Odense S
Tel. +45 66 14 44 00
Fax +45 66 14 44 50

BRADY France

Parc EURO CIT
45, avenue de l'Europe
59436 Roncq Cedex
Tel. +33 (0) 3 20 76 94 48
Fax +33 (0) 3 20 01 08 76

BRADY Germany

Brady-Straße 1
63329 Egelsbach
Tel. +49 (0) 6103 7598 660
Fax +49 (0) 6103 7598 670

BRADY Hungary

Puskás Tivadar u. 4.
2040 Budaörs
Tel. +36 23 500 275
Fax +36 23 500 276

BRADY Italy

Via Degli Abeti 44
20064 Gorgonzola (MI)
Tel: +39 02 26 00 00 22
Fax: +39 02 25 75 351

BRADY Middle East FZE

PO BOX 18015
Jebel Ali, Dubai, UAE
Tel. +971 4881 2524
Fax +971 4881 3183

BRADY Norway

Kjeller Vest 2
2007 Kjeller
Tel. +47 70 13 40 00
Fax +47 70 13 40 01

BRADY Romania

World Trade Center
Piata Montreal, nr 10
Intrarea F, Etajul 1, Birou 1.16,
Sector 1,
Bucharest, 011469
Tel: +40 21 202 3032
Fax: +40 21 202 3100

BRADY Russia

"Kalanchevskaya Plaza" Business
Center, Office 107, 16 building 1,
Kalanchevskaya st.,
Moscow, 129090
Tel: +7 495 269 47 87

BRADY Spain & Portugal

Av. Ventisquero de la condesa 13,
local 17 y 18
28035 Madrid, Spain
Tel. +34 900 902 993
Fax +34 900 902 994

BRADY Sweden

Norgegatan 2
164 32 Kista
Tel. +46 (0) 8 590 057 30
Fax +46 (0) 8 590 818 68

BRADY Turkey

Esentepe Mahallesi, Harman Sokak,
No: 4, Duran İş Merkezi, Kat:10,
34394, Levent, Şişli
Istanbul
Tel. +90 212 264 02 20 / 264 02 21
Fax +90 212 270 83 19

BRADY UK & Ireland

Wildmere Industrial Estate
Banbury, Oxon – OX16 3JU, UK
Tel. +44 (0) 1295 228 288
Fax +44 (0) 1295 228 219

BRADY WORLDWIDE

Australia	612-8717-6300
Brazil	55-11-3686-4720
Canada	1-800-263-6179
China (Beijing)	86-10-6788-7799
China (Shanghai)	86-21-6886-3666
China (Wuxi)	86-510-528-2222
Hong Kong	852-2359-3149
Japan	81-45-461-3600
Korea	82-2-861-8544
Latin America	1-414-540-5560
Malaysia	60-4-646-2700
Mexico	525-399-6963
New Zealand	61-2-8717-2200
Philippines	63-2-658-2077
Singapore	65-6477-7261
Taiwan	886-3-327-7788
Thailand	66-2-793-9200
USA	1-800-537-8791

Your distributor